

Magellan™ 3200VSi
On-Counter Vertical Presentation Scanner

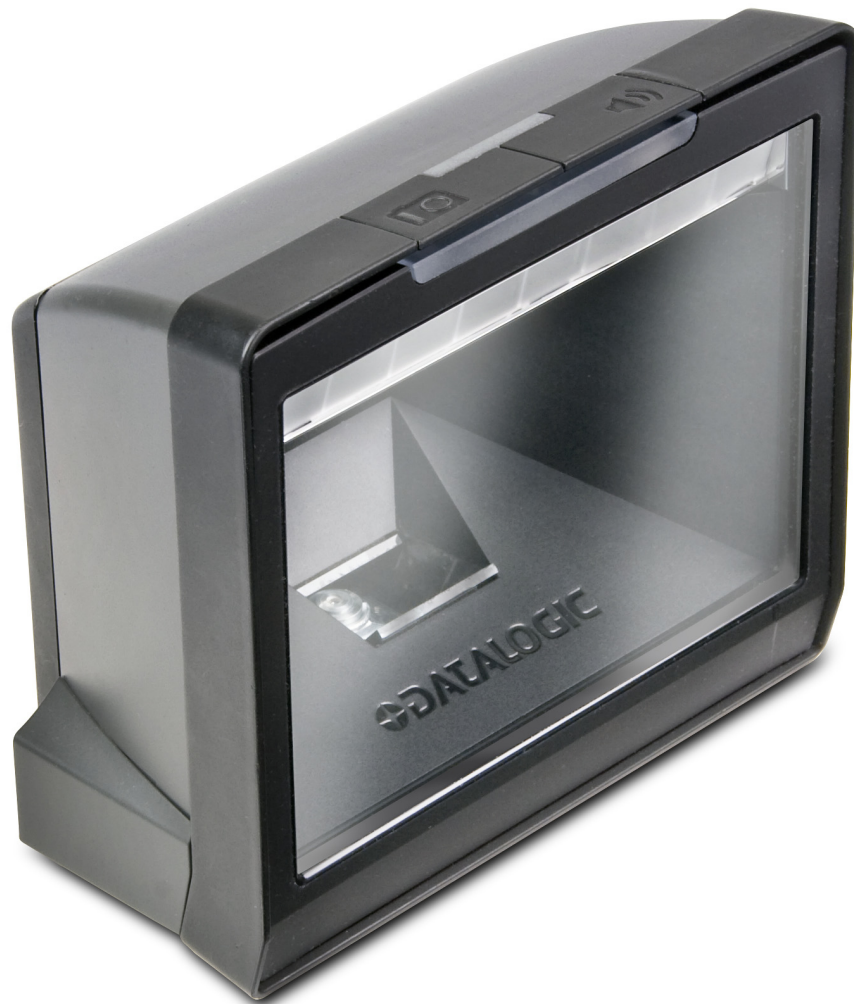

Product Reference Guide

Datalogic Scanning, Inc.

959 Terry Street

Eugene, Oregon 97402

USA

Telephone: (541) 683-5700

Fax: (541) 345-7140

An Unpublished Work - All rights reserved. No part of the contents of this documentation or the procedures described therein may be reproduced or transmitted in any form or by any means without prior written permission of Datalogic Scanning, Inc. or its subsidiaries or affiliates ("Datalogic" or "Datalogic Scanning"). Owners of Datalogic products are hereby granted a non-exclusive, revocable license to reproduce and transmit this documentation for the purchaser's own internal business purposes. Purchaser shall not remove or alter any proprietary notices, including copyright notices, contained in this documentation and shall ensure that all notices appear on any reproductions of the documentation.

Should future revisions of this manual be published, you can acquire printed versions by contacting your Datalogic representative. Electronic versions may either be downloadable from the Datalogic website (www.scanning.datalogic.com) or provided on appropriate media. If you visit our website and would like to make comments or suggestions about this or other Datalogic publications, please let us know via the "Contact Datalogic" page.

Disclaimer

Datalogic has taken reasonable measures to provide information in this manual that is complete and accurate, however, Datalogic reserves the right to change any specification at any time without prior notice.

Datalogic and the Datalogic logo are registered trademarks of Datalogic S.p.A. in many countries, including the U.S.A. and the E.U. All other brand and product names may be trademarks of their respective owners.

Magellan is a registered trademark of Datalogic Scanning, Inc. in many countries, including the U.S.A. and the E.U.

This product may be covered by one or more of the following patents: US5179270 • US5837983 • US6705527 • US6729603 • US6758403 • US6877663 • US7108170 • US7234641 • US7299975

Table of Contents

Chapter 1. Getting Started	1
About This Manual	1
Manual Conventions	1
Connecting the Scanner	2
Error Codes	4
Mount Installation	4
Wall Mount	6
Countertop Mount	6
LED and Beeper Indicators	7
Programming	8
Using the Programming Bar Codes	8
Resetting the Standard Product Defaults	8
Data Matrix Programming Labels	8
Bar Code Mask	9
Going Green	10
LED Class	10
Chapter 2. General Features	11
Double Read Timeout for Linear Labels	11
Double Read Timeout for 2D Labels	13
Scanner Button Options	14
Camera Button Mode	15
Auto Cell Phone Mode	16
Auto Cell Phone Mode Enable	16
LED Level	17
Auxiliary Port Mode	18
Auxiliary Port Baud Rate	19
Productivity Index Reporting (PIR)	20
Sleep Mode	21
LED and Beeper Indicators	23
Power On Alert	23
External Read Indicator (ERI) Active State High	23
ERI Timeout	24
Good Read: When to Indicate	25
Good Read Beep Control	26
Good Read Beep Frequency	26
Good Read Beep Length	27
Good Read Beep Volume	28
Scanning Features	29
Wake Up Intensity	29
Chapter 3. Image Capture	31
Image Capture	31
How to Capture an Image	31
Image Capture to a microSD Card by Scanning a Special Label	31
Image Capture to the Host by Host Command	32
Image Compression	33
Image Format	33
Image Size	34
Image Brightness	35
Image Contrast	35
Chapter 4. Interface Related Features	37
Interface Selection	39
Interface Features	41
Obey/Ignore Host Commands	41

Host Transmission Buffers	42
RS-232 Interface Features	43
Hardware Flow Control	45
Intercharacter Delay	46
Software Flow Control	47
Host Echo	48
Host Echo Quiet Interval	49
Signal Voltage: Normal/TTL	50
RS-232 Invert	51
Beep on ASCII BEL	51
Beep on Not on File	52
ACK NAK Options	53
ACK Character	54
NAK Character	54
Retry on ACK NAK Timeout	55
ACK NAK Timeout Value	55
ACK NAK Retry Count	56
ACK NAK Error Handling	57
Transmission Failure Indication	58
Single Cable RS-232	58
Single Cable RS-232 Options	58
Single Cable RS-232 RTS CTS Selection	59
Single Cable RS-232 Use BCC	60
Single Cable RS-232 Use ACK/NAK	60
Single Cable RS-232 Use STX	61
Set Single Cable RS-232 STX Character	61
Single Cable RS-232 Use ETX	62
Set Single Cable RS-232 ETX Character	62
Single Cable Pacesetter Plus	63
Single Cable Datalogic Extensions	63
USB-OEM Interface Features	64
USB-OEM Device usage	64
IBM	64
IBM Transmit Labels in Code 39 Format	64
Keyboard Wedge	65
USB Keyboard	65
Caps Lock State	67
USB COM Interface Set-up	71
Chapter 5. Data Editing.....	73
Data Editing Overview	73
Please Keep In Mind...	73
Global Prefix/Suffix	74
AIM ID	75
Label ID	76
Case Conversion	82
Character Conversion	83
Chapter 6. Symbologies.....	85
UPC-A	85
Disable/Enable UPC-A	85
Check Digit Transmission	86
Number System Transmission	86
Expand UPC-A to EAN-13	87
UPC-E	88
Disable/Enable UPC-E	88
Check Digit Transmission	88
Number System Digit	89
Expand to UPC-E to UPC-A	89
Expand UPC-E to EAN13	90
GTIN	91
Expand UPC/EAN to GTIN	91

EAN-13	92
Disable/Enable EAN-13	92
Check Digit Transmission	92
EAN-13 Flag 1 Character	93
ISBN	93
EAN-8	94
Disable/Enable EAN-8	94
Check Digit Transmission	94
EAN Two-Label	96
EAN Two-Label Combined Transmission	96
Price Weight Check Digit	97
Add-ons	98
GS1 DataBar Omnidirectional / Stacked Omnidirectional	100
Disable/Enable GS1 DataBar Omnidirectional	100
UCC/EAN 128 Emulation	100
GS1 DataBar Expanded / Expanded Stacked	101
Disable/Enable GS1 DataBar Expanded	101
GS1-128 Emulation	101
Length Control	102
GS1 DataBar Expanded Length 1, Length 2 Programming Instructions	102
Coupon Read Control	103
GS1 DataBar Limited	104
Disable/Enable GS1 DataBar Limited	104
GS1-128 Emulation	104
Code 39	105
Disable/Enable Code 39	105
Check Character Calculation	105
Check Character Transmit	106
Start/Stop Characters	106
Code 39 Full ASCII	107
Length Control	108
Code 39 Length 1, Length 2 Programming Instructions	108
Code 32 Italian Pharmacode	109
Disable/Enable Code 32 Italian Pharmacode	109
Start/Stop Characters	109
Code 32 Italian Pharmacode — continued	110
Check Character Transmit	110
Code 128	111
Disable/Enable Code 128	111
Disable/Enable EAN 128	111
Transmit Function Characters	112
Length Control	113
Code 128 Length 1, Length 2 Programming Instructions	113
Code 128 Conversion to Code 39	114
Interleaved 2 of 5	114
Disable/Enable Interleaved 2 of 5	114
Check Digit Calculation	115
Check Digit Transmit	115
Length Control	116
Interleaved 2 of 5 Length 1, Length 2 Programming Instructions	116
Codabar	117
Disable/Enable Codabar	117
Check Character Verification	117
Check Character Transmit	118
Length Control	119
Codabar Length 1, Length 2 Programming Instructions	119
Start/Stop Character Type	120
Start/Stop Character Transmission	120
Start/Stop Character Match	121
Code 93	121
Disable/Enable Code 93	121
Length Control	122

Code 93 Length 1, Length 2 Programming Instructions	122
MSI	123
Disable/Enable MSI	123
MSI Check Character Transmit	123
MSI Check Character Calculation	124
MSI Number of Check Characters	124
MSI Length Control	125
MSI Length 1, Length 2 Programming Instructions	125
Chapter 7. 2D Symbologies	127
2D Symbologies	127
PDF 417	128
Disable/Enable PDF 417	128
Allow Zero Length PDF 417 Reading	128
Length Control	129
PDF 417 Length 1, Length 2 Programming Instructions	130
Micro PDF 417	131
Disable/Enable Micro PDF 417	131
Length Control	132
Micro PDF 417 Length 1, Length 2 Programming Instructions	133
Datamatrix	134
Disable/Enable Datamatrix	134
Length Control	135
Datamatrix Length 1, Length 2 Programming Instructions	136
QR Code	137
Disable/Enable QR Code	137
Length Control	138
QR Code Length 1, Length 2 Programming Instructions	139
Maxicode	140
Disable/Enable Maxicode	140
Length Control	141
Maxicode Length 1, Length 2 Programming Instructions	142
Aztec	143
Disable/Enable Aztec	143
Length Control	144
Aztec Length 1, Length 2 Programming Instructions	145
Composite Labels	146
Disable/Enable GS1 DataBar Omnidirectional 2D Component	146
Disable/Enable GS1 DataBar Expanded 2D Component	146
Disable/Enable GS1 DataBar Limited 2D Component	147
Chapter 8. Advanced Decoding Features.....	149
Inverse Label Reading	149
UPC/EAN Quiet Zone	150
Chapter 9. References	151
Global Prefix/Suffix	152
Label ID	153
Length Control	154
Length 1, Length 2 Programming Instructions	154
Appendix A. Product Specifications.....	155
Optical and Read Performance Parameters	155
Scanner Dimensions	155
Physical Properties	156
Electrical Parameters	156
Environmental Parameters	156
Other Parameters	156
Appendix B. Cable Pinouts.....	157
Standard Cable Pinouts (Primary Interface Cables)	157

Appendix C. Alpha-Numeric Pad	159
Appendix D. Factory Default Settings	161
Factory Defaults by Interface	161
Appendix E. Keyboard Function Key Mappings.....	167
Keyboard Model Cross Reference	167
Appendix F. Host Commands	175
Accepting RS-232 Commands	175
Appendix G. Sample Symbols.....	177
1D Symbol Samples	177
2D Sample Symbols	179
Composite Sample Symbols	180
Appendix H. microSD Card	181
microSDHC Compatibility	181
microSD Card Insertion	181
microSD Card Removal	182
Autorun File Processing	182
microSD Function Summary	182
microSD Function Details	183
From Scanner to microSD Card	183
Capture and save an image to a microSD card by scanning a label.	183
Export a Configuration file from the Scanner to the microSD card	183
Export Scanner Status to microSD card	184
From microSD Card to Scanner	184
Application code load to scanner	184
Configuration load to scanner	185
Appendix I. Handheld Data Format Requirements.....	187
Handheld Data Format Requirements General	187
Datalogic Handheld Data Format Requirements	188
RSS-14	188
RSS Expanded	188
UPC-A	188
UPC-A with 2-Digit Supplemental	188
UPC-A with 5-Digit Supplemental	188
UPC-A with Code 128 Supplemental	188
UPC-E	189
UPC-E with 2-Digit Supplemental	190
UPC-E with 5-Digit Supplemental	190
UPC-E with Code 128 Supplemental	190
EAN-8	191
EAN-8 with 2-Digit Supplemental	191
EAN-8 with 5-Digit Supplemental	191
EAN-8 with Code 128 Supplemental	191
EAN-13	191
EAN-13 with 2-Digit Supplemental	191
EAN-13 with 5-Digit Supplemental	191
EAN-13 with Code 128 Supplemental	192
Code 39	192
Code 39-Pharmacode	192
I 2 of 5	192
Codabar	193
Code 128	193
MSI	194
Code 93	194
PDF417	194
AIM Formats	195

UPC-A	195
UPC-E	195
EAN-13	195
EAN-8	195
2-Digit Supplemental	195
5-Digit Supplemental	196
Code 128 Supplemental	197
Bookland	197
Code 39	197
Codabar	197
MSI	198
Code 93	198
RSS-14	199
RSS Expanded	199
1 2 of 5	199
Code 128 / EAN128	200
PDF417	200
"Unknown" AIM ID (an AIM ID which is not specified above)	200

Chapter 1

Getting Started

The Magellan™ 3200VSi On-Counter Vertical Presentation Scanner is designed for small counter retail checkout environments where there is a relatively high number of transactions with a fairly small number of items per transaction. The scanner has a reduced footprint, allowing more room for item merchandising of high margin impulse items clustered around the P.O.S.

About This Manual

This manual provides advanced user information, including connection, programming, product and cable specifications, and other useful references. For additional information, such as installation, maintenance, troubleshooting and warranty information, see the Quick Reference Guide (QRG). Copies of other publications for this product are downloadable free of charge from the website listed on the back cover of this manual.

On leaving the factory, units are programmed for the most common terminal and communications settings. If you need to change these settings, custom programming can be accomplished by scanning the bar codes in this guide.

Bold text and a yellow-highlighted background indicates the most common default setting for a feature/option.

Manual Conventions

The symbols listed below are used in this manual to notify the reader of key issues or procedures that must be observed when using the scanner:



Notes contain information necessary for properly diagnosing, repairing and operating the scanner.

NOTE



The **CAUTION** symbol advises you of actions that could damage equipment or property.

CAUTION

Connecting the Scanner

The scanner kit you ordered to match your interface should provide a compatible cable for your installation. Alternatively, if your scanner receives Power Off the Terminal (POT) it might be possible to connect using a cable from a previously existing installation (except for USB). If you wish to connect using an existing cable, but cannot use POT, a short adapter cable is available. Check with your technical support representative about compatibility before connecting. Use the appropriate instructions below when you're ready to connect the scanner to the terminal, PC or other host device.

Upon completing the connection via the appropriate interface instructions below, proceed to the [Interface Related Features](#) section of this manual and scan the bar code to select the correct interface type.

RS-232 Serial Connection — Turn off power to the terminal/PC and connect the scanner to the terminal/PC serial port via the RS-232 cable as shown in [Figure 1a](#). If the terminal will not support POT (Power Off the Terminal) to supply scanner power, use the approved power supply (AC Adapter) as shown in [Figure 1b](#). Plug the AC Adapter barrel connector into the socket on the RS-232 cable connector and the AC Adapter plug into a standard power outlet.

Figure 1. Connecting the Scanner

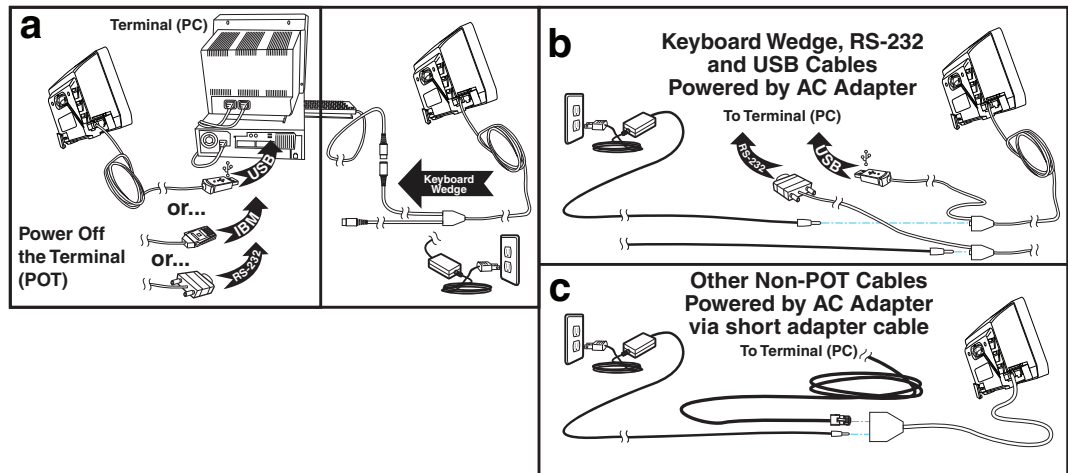

USB Connection — Connect the scanner to a USB port on the terminal/PC using the correct USB cable for the interface type you ordered. Reference [Figure 1](#).



NOTE

USB installations may require a power connection via an approved A/C Adapter as shown in [Figure 1b](#) or [Figure 1c](#). For example, this would be the case if the scanner is connected along with a number of other devices to a non-powered USB hub.

IBM Connection — Connect the scanner to the IBM port on the terminal/PC using the correct IBM cable. Reference [Figure 1](#).

Keyboard Wedge Connection — Before connection, turn off power to the terminal/PC. The Keyboard Wedge cable has a ‘Y’ connection from the scanner. Connect the female to the male end from the keyboard and the remaining end at the keyboard port at the terminal/PC. Reference Figure 1a.

Figure 2. Labeling and Nomenclature

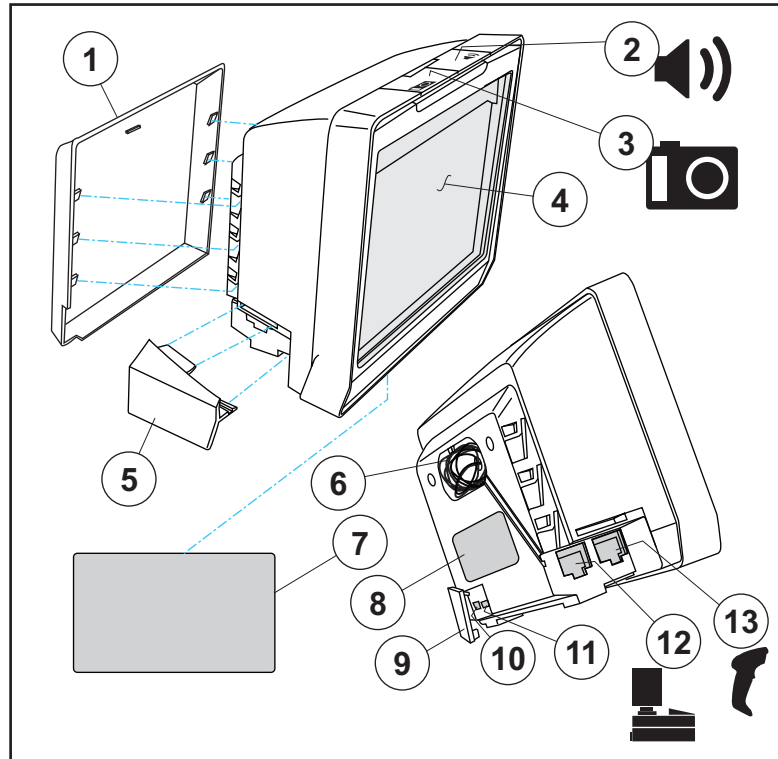

1	Back Cover	8	P/N Label
2	Scanner Push Button	9	USB/SD Cover
3	Camera Push Button	10	USB Service Port — On Screen Programming Tool
4	Scan Window	11	microSD Card Slot — Upgrade, imaging, statistics data
5	Cable Connector Cover	12	Host (blue) Port— POS terminal, label data, application host download, host commands to scanner
6	Checkpoint EAS Wire Cavity Electrical Article Surveillance Antenna Connection	13	Auxiliary (yellow) Port for RS-232 handheld scanner, EAS Interlock, PIR data, etc.
7	Serial Number/Regulatory Label		

Error Codes

If an error is detected, the scanner will sound a long low tone (for three seconds) and flash its LED, indicating a failure. When this occurs, press the Scanner Pushbutton to hear the error code. If it is configured to do so, the scanner will sound a series of beeps corresponding to the error code and/or flash its LED simultaneous to the beeps. The table below describes what these codes mean and what action should be taken for each.

NUMBER OF LED FLASHES/ BEEPS	ERROR	CORRECTIVE ACTION
1	Configuration	Contact Helpdesk for assistance
2	Interface PCB	
6	Main PCB	
10	Button Error	
12	Imager Module	
13	Software ID Failure	
14	Software Fatal Fault	

Mount Installation

Options for mounting the scanner to a wall or countertop include an L-Bracket or stackable Risers (straight or tilted). [Figure 3](#) shows the scanner being seated in an L-Bracket. [Figure 4](#) demonstrates the use of stackable Risers.



NOTE

Stackable Risers also require use of the L-Bracket in order to securely seat the scanner in the topmost riser.

Figure 3. L-Bracket Mount

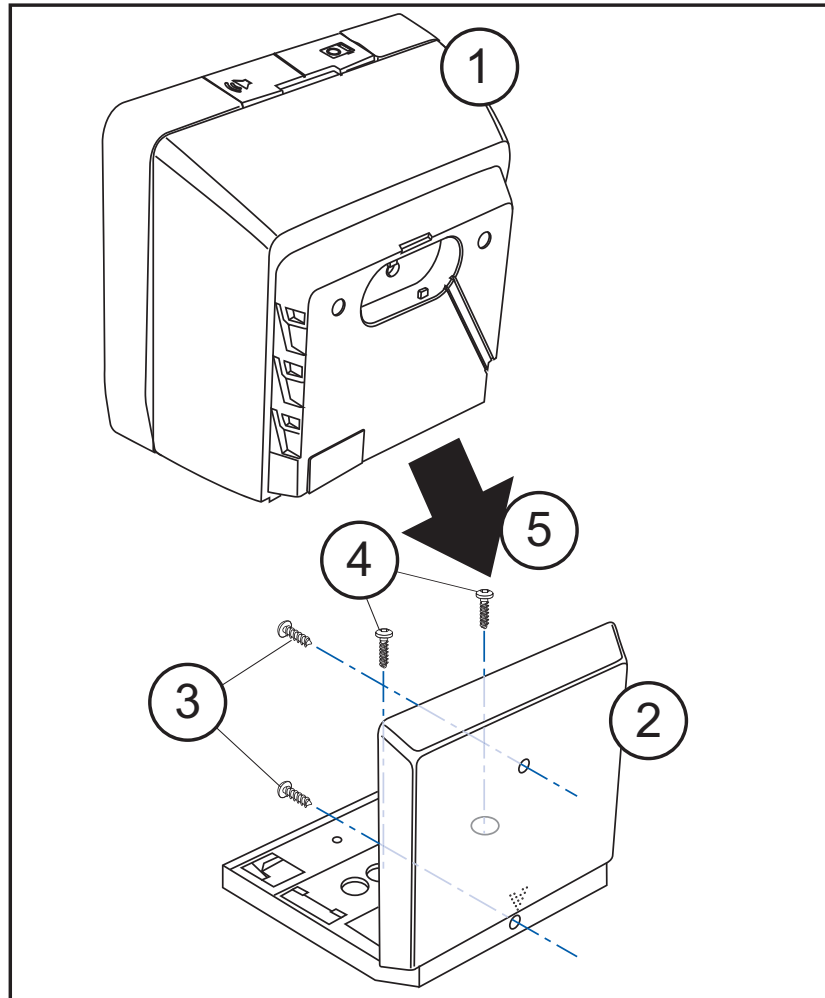

1. Scanner
2. L-Bracket
3. Wall Mounting Screws
4. Countertop Mounting Screws
5. Move the scanner toward the bracket in a diagonal motion to seat it.

Figure 4. Using the Risers

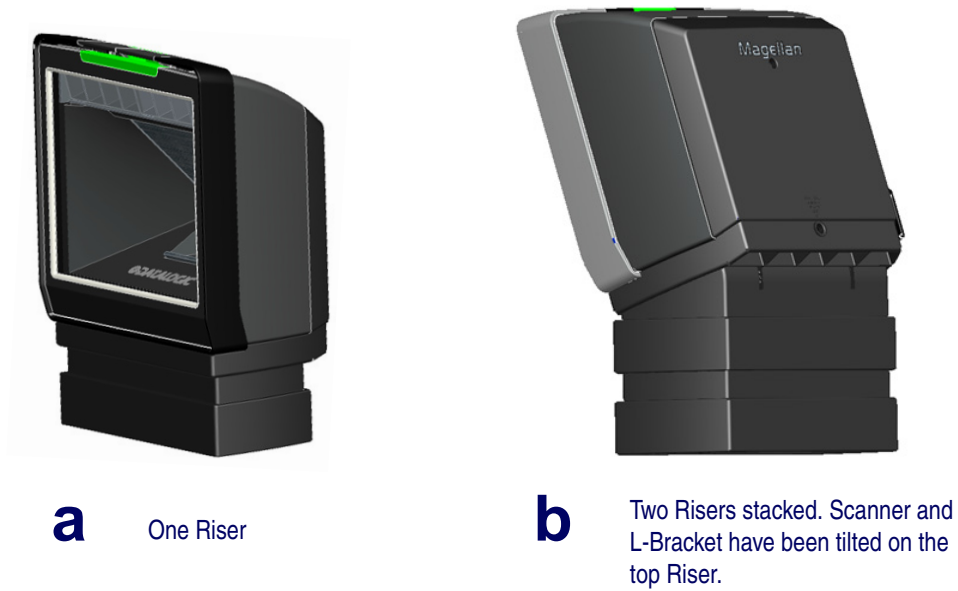

Wall Mount

Attach the L-Bracket to the wall, securing it in the desired position with two screws through the two holes in the back face of the L-Bracket as shown in [Figure 3](#). Recommendation: Use two Pan Head (8.2mm or 5/16" maximum head diameter) #8 screw with a thread profile that suits the mounting surface material in the wall.

Countertop Mount

If using the L-Bracket alone for countertop installation, secure the bracket in place using two screws through the bottom face of the bracket (see [Figure 3](#)). If risers are used, secure a riser to the countertop by attaching two screws through its screw holes. Recommendation: Use two Pan Head (8.2mm or 5/16" maximum head diameter) #8 screw with a thread profile that suits the mounting surface material in the countertop.



CAUTION

Do not use a countersink type of screw head. Damage will occur from use of a countersunk screw head in the plastic screw bosses

Risers may be stacked as shown in [Figure 4b](#). Each riser increments the height of the mounted scanner by 1.5" (38.1mm). Riser pieces readily snap together or apart and allow for adjustable tilt of the scanner/L-Bracket of up to 20 degrees in 5° increments. [Figure 4b](#) provides an example of a tilted scanner.

LED and Beeper Indicators

The scanner's beeper sounds and its green LED illuminates to indicate various functions or errors on the scanner. The tables below list these indications. One exception to the behaviors listed in the tables is that the scanner's functions are programmable, and may or may not be turned on. For example, certain indications, such as the power-up beep can be disabled using programming bar code labels.

Green LED Indications

LED INDICATION	INDICATION	COMMENT
Power-on indication	Bright green flash	Indicates the scanner has finished all its power up tests and is now ready for operation.
Good Read Indication	Bright green flash	Indicates a bar code has been read and decoded.
Scanner Ready	Constant dim green	The scanner is ready for operation. The LED is also configurable to off when idle and ready for operation
Sleep Mode	Green LED slowly and continuously changes from off to dim to off.	The scanner is in Sleep Mode. To wake the scanner up, move an object in front of its window or press the button atop the unit. This indication is optionally configurable and may have been programmed to behave differently.
Host Disable	Constant green flash at 1 Hz (100mS on, 900mS off)	The scanner is disabled due to receiving a disable command from the POS terminal.
Diagnostics	Varies (see "Error Codes" on page 1-4 for more information)	The LED can provide diagnostic feedback if the scanner discovers a problem during SelfTest.
Prog. Mode	See Host Disable above.	The scanner is in Programming Mode.

BEEPER FUNCTIONS

BEEPER INDICATION	INDICATION	COMMENT
Power On Beep	Single beep	The Power-On Beep indication is a configurable feature which can be enabled or disabled. When enabled, this beep indicates the scanner has finished all its power up tests and is now ready for operation.
Good Read Indication	Single beep	The good read beep indication is configurable. Options include: Enable/disable, frequency, duration and volume. See LED and Beeper Indicators on page 23 for more information.
Diagnostics	Varies (see "Error Codes" on page 1-4 for more information)	The Beeper can provide diagnostic feedback if the scanner discovers a problem during SelfTest.

BEEPER FUNCTIONS

BEEPER INDICATION	INDICATION	COMMENT
Programming Mode Indications	Varies depending upon the feature(s) being configured.	The Beeper will sound as programming bar code labels are scanned, indicating progress during scanner configuration.

Programming

The scanner is typically factory-configured with a set of default features standard to the interface type you ordered. After scanning the interface bar code from the [Interface Related Features](#) section, you can select other options and customize your scanner through use of the instructions and programming bar codes available in that section and also the [Data Editing](#) and [Symbologies](#) chapters of this manual.

Using the Programming Bar Codes

This manual contains feature descriptions and bar codes which allow you to reconfigure your scanner. Some programming bar code labels, like the label below for resetting defaults, require only the scan of that single label to enact the change. Most of the programming labels in this manual, however, require the scanner to be placed in Programming Mode prior to scanning them. Scan a START/END bar code once to enter Programming Mode. Once the scanner is in Programming Mode, you can scan a number of parameter settings before scanning the START/END bar code a second time, which will then accept your changes, exit Programming Mode and return the scanner to normal operation.

Resetting the Standard Product Defaults

If you are unsure of what programming options are in your scanner, or you've changed some options and want the factory settings restored, scan the *Standard Product Default Settings* bar code below. This will copy the factory configuration for the currently active interface to the current configuration.

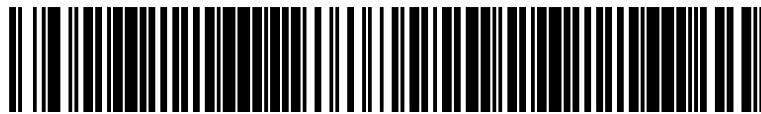

Standard Product Default Settings

The programming section lists the factory default settings for each of the menu commands for the standard RS-232 interface in **BOLD** text on the following pages. Exceptions to default settings for the other interfaces can be found in [Appendix D, Factory Default Settings](#).

Data Matrix Programming Labels

Some scanners can be configured using Data Matrix programming labels. This feature is **ONLY** available for scanners with 2D capability.

Contact Technical Support to request Data Matrix programming labels.

Bar Code Mask



Cut a hole in this page and remove it from the manual as indicated to create a sleeve through which bar codes (starting in the following section) can be individually viewed and scanned. It is important that only one bar code at a time be presented to the scanner.

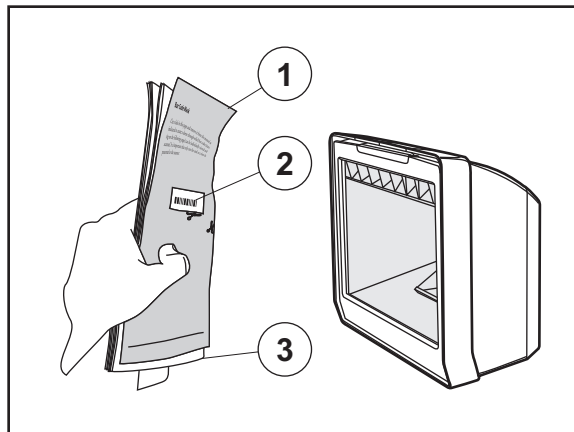
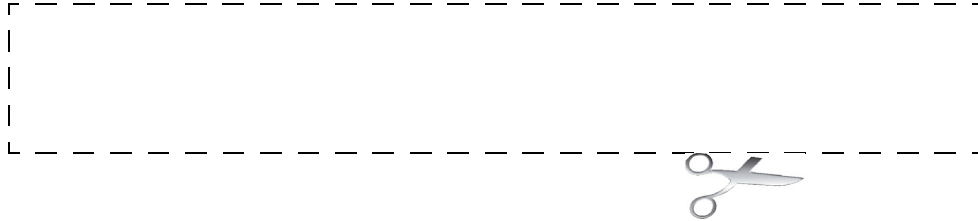

1. Bar Code Mask Sheet
2. Bar Code

3. Manual (folded)

Going Green

Thank you for using the bar code mask on the opposite side of this page. This manual has been formatted to minimize the quantity of pages needed to provide all of the programming bar codes available for this product.



LED Class

CLASS 1 LED PRODUCT APPARECCHIO LED CLASSE 1

LED KLASSE 1 APPAREIL A LED DE CLASSE 1

IEC / EN 60825-1:2007

Max output of LED radiation: 3.21mW per pulse at 100mm

Pulse duration: 200µs

Emitted wavelength 625nm

Chapter 2



General Features

Double Read Timeout for Linear Labels

This Double Read Timeout feature sets a time limit that determines how much time must pass before reading the same linear label again (e.g. two identical items in succession).







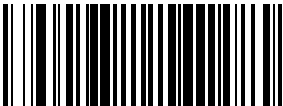

	START / END
PROGRAMMING bar codes	
0.1 Second	
	0.2 Second
0.3 Second	
	0.4 Second DEFAULT
0.5 Second	
	0.6 Second

Double Read Timeout for Linear Labels — cont.

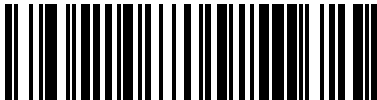
	START / END
PROGRAMMING bar code	
0.7 Second	
	0.8 Second
0.9 Second	
	1 Second

Double Read Timeout for 2D Labels

This Double Read Timeout feature specifies the minimum allowable time between consecutive good reads of the same PDF 417, Micro PDF 417 Data Matrix, QR Code, Maxicode, Aztec or Composite label.



	START / END
PROGRAMMING bar codes	
0.7 Second DEFAULT	
	1 Second
1.5 Seconds	
	1.65 Seconds
1.8 Seconds	
	1.95 Seconds
2 Seconds	
	2.55 Seconds

Scanner Button Options

This feature allows the user to configure the scanner (volume) button to different modes of operation.

Options are:

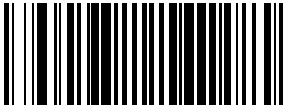
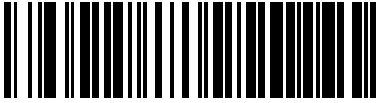
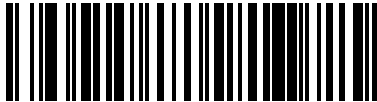
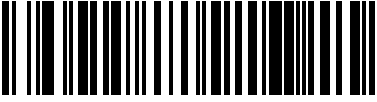
- All functions (volume, tone, diagnostics, and reset)
- Enable only volume, tone, and reset
- Enable reset only
- Disable all button functions

	START / END
PROGRAMMING bar codes	
Scanner Button Options = All functions	
	Scanner Button Options = Enable only volume, tone, and reset DEFAULT
Scanner Button Options = Enable reset only	
	Scanner Button Options = Disable all button functions

Camera Button Mode

Controls the function associated with the "Picture Taking" button

Options are:

- Normal Take Picture operation
- Activates Cell Phone Toggle Mode when not taking picture
- Activates Cell Phone One-Shot Mode when not taking pictures

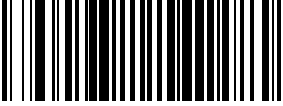
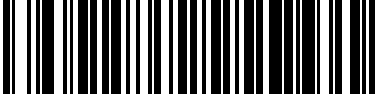
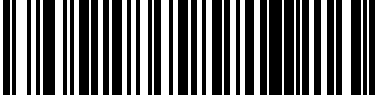
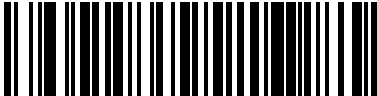



	START / END
PROGRAMMING bar codes	
<p>Camera Button Mode = Normal Take Picture operation DEFAULT</p>	
	<p>Camera Button Mode = Activates Cell Phone Toggle Mode when not taking picture</p>
<p>Camera Button Mode = Activates Cell Phone One-Shot Mode when not taking pictures</p>	

Auto Cell Phone Mode

Auto Cell Phone Mode enables the scanner to read bar codes on a cell phone display without user intervention. For high ambient light conditions, button cell phone mode is recommended. (See “Camera Button Mode” on page 15.)



Auto Cell Phone Mode Enable

Enables/disables Auto Cell Phone Mode.

START / END	
PROGRAMMING bar codes	
	Auto Cell Phone Mode = Disable DEFAULT
Auto Cell Phone Mode = Enable Normal	
	Auto Cell Phone Mode = Enable Sensitive
Auto Cell Phone Mode = Enable Sensitive Ambient	

LED Level

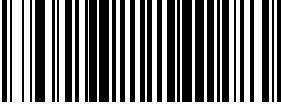
This feature defines the LED intensity level by pulse width.

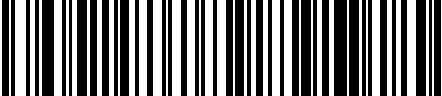
	START / END
PROGRAMMING bar codes	
LED Level = Medium DEFAULT	
	LED Level = Low
LED Level = High	

Auxiliary Port Mode

Specifies the function associated with the auxillary interface.

Choices are:

- Disabled
- 01=Serial Handheld Enabled
- 02=PIR/CT Output plus Diagnostics Reporting

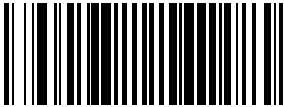
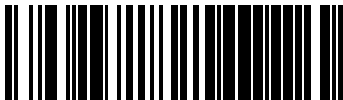
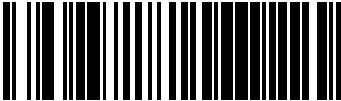
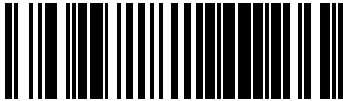
	START / END
PROGRAMMING bar codes	
Disable Auxiliary Port Mode DEFAULT	
	Auxiliary Port Mode = Serial Handheld Enabled
Auxiliary Port Mode = PIR/CT Output plus Diagnostics Reporting	

Auxiliary Port Baud Rate

Specifies baud rate of auxiliary port when operating in PIR/CT mode.

	START / END
PROGRAMMING bar codes	
Auxiliary Port Baud Rate = 1200	
	Auxiliary Port Baud Rate = 2400
Auxiliary Port Baud Rate = 4800	
	Auxiliary Port Baud Rate = 9600
Auxiliary Port Baud Rate = 19200 DEFAULT	
	Auxiliary Port Baud Rate = 38400
Auxiliary Port Baud Rate = 57600	
	Auxiliary Port Baud Rate = 115200



Productivity Index Reporting (PIR)

When PIR is enabled, label quality data is appended to decoded data before being presented to the POS. The PIR feature allows the scanner to provide information to an external computer, indicating how easy the label was to read.





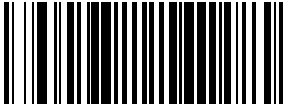



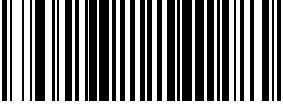

NOTE

This value-added feature is a factory-programmed option. Contact your dealer for information about upgrading your system to include this advanced capability.









	START / END
PROGRAMMING bar codes	
Disable DEFAULT	
	Enable

Sleep Mode

This feature specifies the amount of time with no bar code reads before the scanner enters sleep mode.

	START / END
PROGRAMMING bar codes	
	Disable Sleep Mode
15 Seconds	
	30 Seconds
1 Minute	
	2 Minutes
3 Minutes	
	4 Minutes
5 Minutes DEFAULT	



Sleep Mode — cont.

START / END	
PROGRAMMING bar codes	
	6 Minutes
7 Minutes	
	8 Minutes
9 Minutes	
	10 Minutes DEFAULT
12 Minutes	
	15 Minutes
30 Minutes	
	1 Hour

LED and Beeper Indicators

Power On Alert

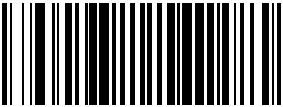
Disables or enables the indication (a single beep) that the scanner has finished all its power up tests and is now ready for operation.

	START / END
PROGRAMMING bar codes	
Disable	
	Enable DEFAULT

External Read Indicator (ERI) Active State High



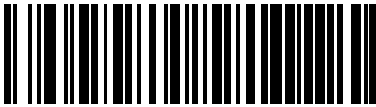
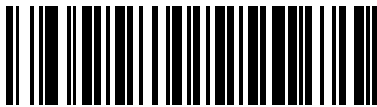

This feature is available only through use of a special cable.

NOTE

START / END	
PROGRAMMING bar codes	
	ERI Active State = High
ERI Active State = Low DEFAULT	

ERI Timeout

Specifies the amount of time the External Read Indicator (ERI) signal is held active for a good read.

START / END	
PROGRAMMING bar codes	
<p>Sets the ERI timeout duration using hex values from 000 to 255 in increments of ten milliseconds (10ms or 0.01 seconds). To configure this feature, scan the “START/END” bar code above to place the unit in Programming Mode, then the “Set ERI Timeout,” followed by the two digits (zero padded) from the Alphanumeric table in Appendix C, Alpha-Numeric Pad representing the desired time value. Exit programming mode by scanning the “START/END” bar code again.</p> <p style="text-align: center;">DEFAULT SETTING FOR THIS FEATURE: 20 milliseconds (02)</p>	
	Set ERI Timeout

Good Read: When to Indicate

This feature specifies when the scanner will provide indication (beep and/or flash its green LED) upon successfully reading a bar code. Choices are:

- Good Read = Indicate after decode
- Good Read = Indicate after transmit
- Good Read = Indicate after CTS goes inactive, then active





This option (Indicate after CTS goes inactive, then active), which uses CTS, is only valid for RS-232 interfaces.

NOTE

	START / END
PROGRAMMING bar codes	
After Decode DEFAULT	
	After Transmit
After CTS goes inactive, then active	

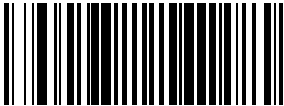

Good Read Beep Control

This feature enables/disables the scanner's ability to beep upon a successful decode of a bar code.

	START / END
PROGRAMMING bar codes	
Disable	
	Enable DEFAULT

Good Read Beep Frequency

Adjusts the good read beep to sound at a selectable low, medium or high frequency, selectable from the list below. (Controls the beeper's pitch/tone.)

	START / END
PROGRAMMING bar codes	
Low	
	Medium DEFAULT
High	



Good Read Beep Length

Specifies the duration of a good read beep.

	START / END
PROGRAMMING bar codes	
60msec	
	80msec DEFAULT
100msec	
	120msec
140msec	
	160msec
180msec	
	200msec

Good Read Beep Volume

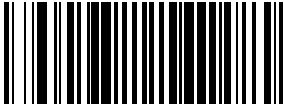

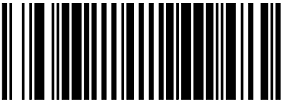



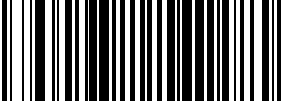

Selects the beeper volume (loudness) upon a good read beep. There are three selectable volume levels.

	START / END
PROGRAMMING bar codes	
Low	
	Medium
High DEFAULT	



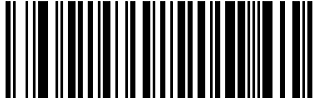

Scanning Features

Wake Up Intensity

This feature indicates the percentage of ambient light change which will trigger the scanner to wake up from Sleep Mode. Lower settings provide greater sensitivity. The selectable range for this setting is 5% to 15%.

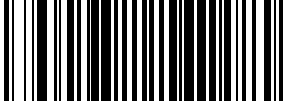
	START / END
PROGRAMMING bar codes	
5%	
	6%
7%	
	8%
9%	
	10% DEFAULT
11%	
	12%

Wake Up Intensity — cont.

	START / END
PROGRAMMING bar codes	
13%	
	14%
15%	

Chapter 3

Image Capture

Image Capture

How to Capture an Image

There are two methods of capturing images as discussed below:

- [Image Capture to a microSD Card by Scanning a Special Label](#)
- [Image Capture to the Host by Host Command](#)

Image Capture to a microSD Card by Scanning a Special Label

Insert a microSD card into the scanner, scan a capture label and place the item to be captured in front of the scanner. Press and release the Camera Button. The image will be written to the microSD card five seconds after button release.

The format, size, contrast, brightness and compression use the configured values.

This Capture label is as follows:

<FNC3>IMAGEFAUTO<CR>

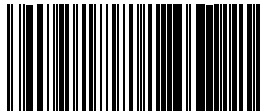

The Capture label will not read unless a microSD card is inserted.

NOTE

The image filename is automatically increased from image000 to image999.

The date image file generated is not actual, since no real time clock is embedded in the scanner.

Image Capture to the Host by Host Command

This feature is only available for RS-232 and USB COM interfaces.



If the USB COM interface has been selected, follow the [USB COM Interface Set-up instructions in the Interface Related Features chapter of this guide.](#)

NOTE

The host command format is as follows:

P<cnt>pSBC

where:

P - ASCII 'P' used as preamble of pass-through commands

<cnt> - binary value of 4 indicating 4 bytes to follow

p - ASCII lowercase 'p' ; command to take a picture

S - size value of image as ASCII character

'S' == uses scanner's configuration value

'0'-VGA, (640X480)

'1'-WVGA, (752X480)

'2'-SXGA, (1280x1027)

'3'-CIF (320x240)

B - brightness value in ASCII

'B' == uses scanner's configuration value CI_IMAGE_BRIGHTNESS

else '0' thru'9' specifies brightness

C - contrast value in ASCII

'C' == uses scanner configuration value CI_IMAGE_CONTRAST

else '0' thru'9' specifies contrast

IF the image is of a type the scanner supports, capture and transmission occurs, and the command is of proper format

THEN

The scanner will transmit an ACK (0x06) to the Host in response to this command.

The image data transmission starts with a 4 byte binary field representing (Big Endian) number of bytes to follow.

If the "number of bytes to follow" value is zero, there was a problem with generating the image and the request should be retried.

ELSE

The scanner will transmit a BEL (0x07) to the Host in response to this command.

ENDIF

Image Compression

Specifies the starting image compression factor for JPEG images. A higher number specifies a higher quality image with less compression than a relative lower number for the same image.

A value of 100 means minimal compression. A value of 1 means maximum compression at a loss of quality. Follow these steps to program this feature:

1. Scan the START bar code.
2. Scan the Set Image Compression bar code.
3. Turn to [Alpha-Numeric Pad](#) and scan the two digits (zero-padded) representing the desired compression. The configurable range is 01-0x64 by increments of 01.
4. Scan the END bar code.

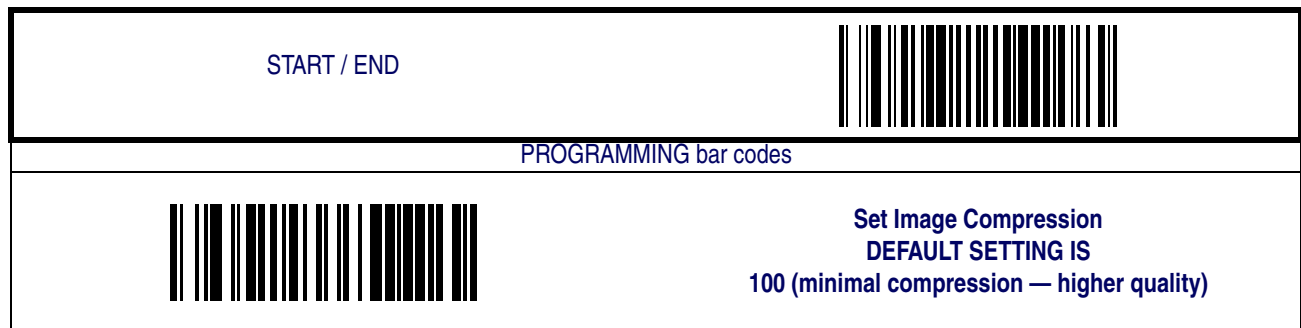

Image Format

Specifies the format of the captured image

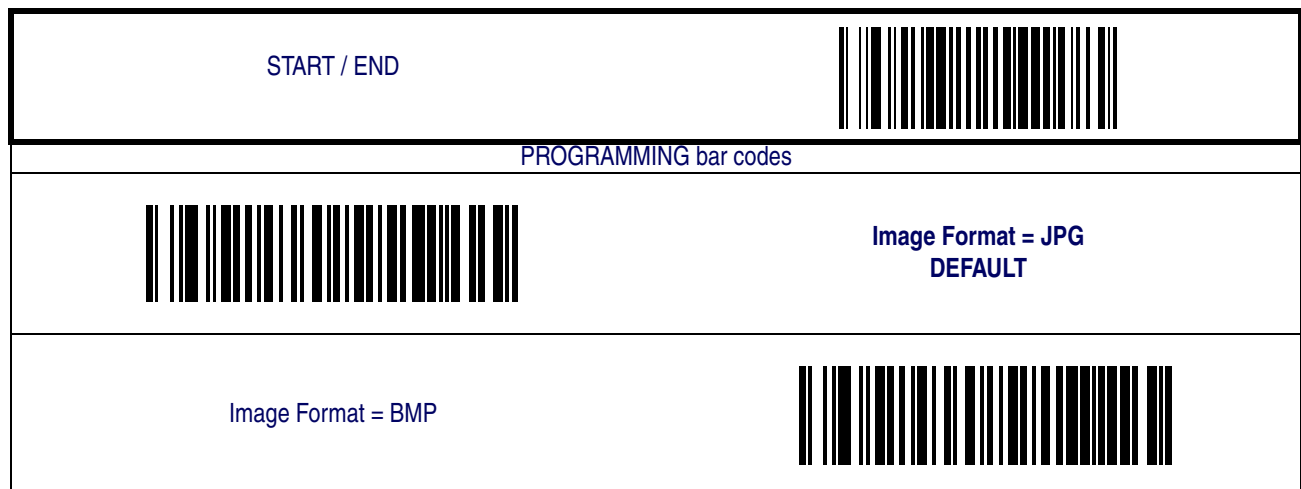

Image Size

Specifies the size of the image capture. Choices are:

- VGA
- WVGA
- SXGA, Full Size
- CIF



START / END	
PROGRAMMING bar codes	
	Image Size = VGA DEFAULT
Image Size = WVGA	
	Image Size = SXGA, Full Size
Image Size = CIF	

Image Brightness

This feature sets the image brightness value. Follow these instructions to configure this feature:

1. Scan the START bar code.
2. Scan the Set Image Brightness bar code.
3. Turn to [Alpha-Numeric Pad](#) and scan the two digits (zero-padded) representing the desired brightness in decimal notation. The configurable range is 01-0x0A by increments of 01.
4. Scan the END bar code.

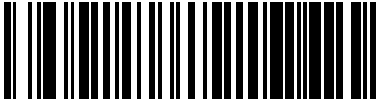
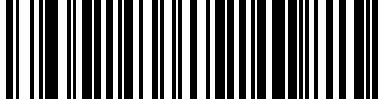
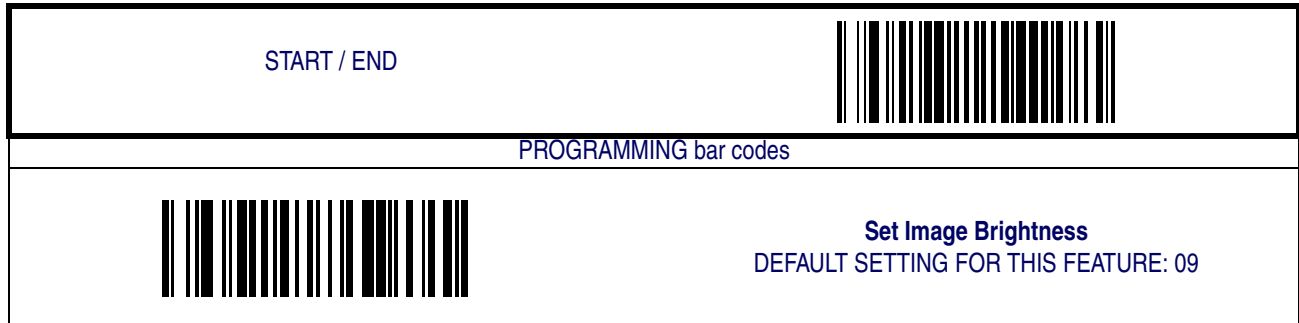
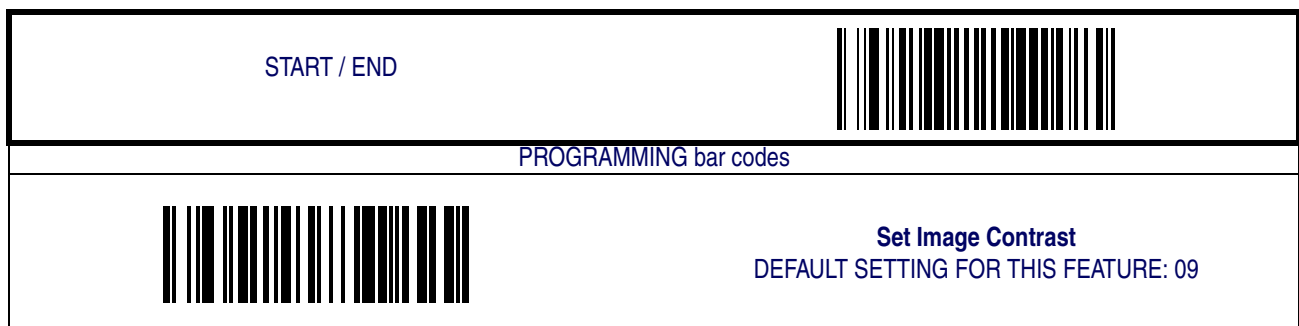

Image Contrast

This feature sets the image contrast value. Follow these instructions to configure this feature:

1. Scan the START bar code.
2. Scan the Set Image Contrast bar code.
3. Turn to [Alpha-Numeric Pad](#) and scan the two digits (zero-padded) representing the desired contrast in decimal notation. The configurable range is 01-0x0A by increments of 01.
4. Scan the END bar code.



NOTES

Chapter 4

Interface Related Features

At the time of this writing, the reader supports the interfaces listed in [Table 1](#). Select the desired interface type from the table, then reference the page number given for the customizable features section associated with each interface. See [Table 2](#) for a description of each Keyboard Wedge interface type (A through Y as listed).

Table 1. Interfaces Supported

	Page	Keyboard Wedge	
RS-232			40
RS-232 Standard	39	Keyboard Wedge A ^a	40
RS-232 Wincor-Nixdorf	39	Keyboard Wedge B ^a	40
IBM		Keyboard Wedge C ^a	40
IBM 4683 Port 5B	39	Keyboard Wedge D ^a	40
IBM 4683 Port 9B	39	Keyboard Wedge E ^a	40
IBM 4683 Port 17	39	Keyboard Wedge F ^a	40
USB		Keyboard Wedge G ^a	40
USB-OEM	39	Keyboard Wedge H ^a	40
USB Keyboard	39	Keyboard Wedge I ^a	40
USB COM Interface	39	Keyboard Wedge J ^a	40

a. Consult [Table 2](#) for more information regarding keyboard interface types.



The correct interface cable is generally included for the reader interface type you ordered.

NOTE

Table 2. Keyboard Wedge Interface Reference

I/F Type	PCs Supported
A	PC/XT w/Alternate Key Encoding
B	AT, PS/2 25-286, 30-286, 50, 50Z, 60, 70, 80, 90 & 95 w/Alternate Key Encoding
C	PS/2 25 and 30 w/Alternate Key Encoding
D	PC/XT w/Standard Key Encoding
E	AT, PS/2 25-286, 30-286, 50, 50Z, 60, 70, 80, 90 & 95 w/Standard Key Encoding
F	PS/2 25 and 30 w/Standard Key Encoding
G	IBM 3xxx w/122 keyboard
H	IBM 3xxx w/102 keyboard
I	PS/55 5530T w/104 keyboard
J	NEC 9801



NOTE

Reference Appendix E, Keyboard Function Key Mappings for more information about keyboards.

Interface Selection

START / END	
PROGRAMMING bar codes	
	RS-232 Standard
RS-232 Wincor-Nixdorf	
	IBM 4683 Port 5B
IBM 4683 Port 9B	
	IBM 4683 Port 17
USB-OEM	
	USB Keyboard
USB COM Interface	



Interface Selection — cont.

START / END	
PROGRAMMING bar codes	
Keyboard Wedge A	
	Keyboard Wedge B
Keyboard Wedge C	
	Keyboard Wedge D
Keyboard Wedge E	
	Keyboard Wedge F
Keyboard Wedge G	
	Keyboard Wedge H
Keyboard Wedge I	
	Keyboard Wedge J

Interface Features

Obey/Ignore Host Commands

When set to ignore host commands, the scanner will ignore all host commands except for the minimum set necessary to keep the interface active and transmit labels. For normal operation of the interface, select Obey Host Commands.



START / END	
PROGRAMMING bar codes	
	Obey Host Commands DEFAULT
Ignore Host Commands	

Interface Features — cont.

Host Transmission Buffers

Specifies the number of host transmission(s) that may be buffered. By buffering data from a bar code, the scanner can continue to read a new bar code while the old one is being transmitted to the host. Selecting BUFFERS = 1 means that the first bar code must be transmitted before a new one can be read. A selection of BUFFERS = 2 means that a new bar code can be read while data from the first bar code is transmitted.

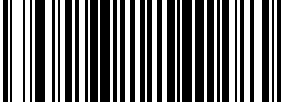
When a DISABLE SCANNER command is received from the host, the scanner will continue to transmit all data that is buffered.

START / END	
PROGRAMMING bar codes	
	Host Transmission Buffers = 1
Host Transmission Buffers = 2 DEFAULT	

RS-232 Interface Features

START / END	
PROGRAMMING bar codes	
Baud Rate	
	1200 Baud
2400 Baud	
	4800 Baud
9600 Baud DEFAULT	
	19200 Baud
38400 Baud	
	57600 Baud
115200 Baud	

RS-232 Interface Features – cont.

START / END	
PROGRAMMING bar codes	
Data Bits	
	7 Data Bits
8 Data Bits DEFAULT	
Stop Bits	
	1 Stop Bit DEFAULT
2 Stop Bits	
Parity	
	Parity = None DEFAULT
Parity = Even	
	Parity = Odd



RS-232 Interface Features — cont.

Hardware Flow Control

Disable Hardware Control— The scanner transmits to the host regardless of any activity on the CTS line.

Enable CTS Flow Control— The CTS signal controls transmission of data to the host.

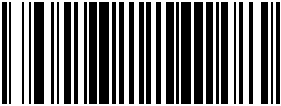
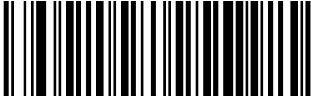
Enable CTS Scan Control— The CTS line must be active for the scanner to read and transmit data. While the CTS line is inactive, the scanner remains in a host-disabled state; following a successful label transmission, the CTS signal must transition to inactive and then to active to enable scanning for the next label.

START / END	
PROGRAMMING bar codes	
	Disable Hardware Control DEFAULT
Enable CTS Flow Control	
	Enable CTS Scan Control



RS-232 Interface Features — cont.

Intercharacter Delay

This delay is inserted after each data character transmitted. If the transmission speed is too high, the system may not be able to receive all characters. You may need to adjust the delay to make the system work properly.

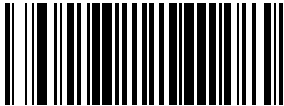

START / END	
PROGRAMMING bar codes	
	Inter-Char Delay = No Delay DEFAULT
Interchar Delay = 10 msec	
	Interchar Delay = 20 msec
Interchar Delay = 30 msec	
	Interchar Delay = 40 msec
Interchar Delay = 50 msec	
	Interchar Delay = 60 msec
Interchar Delay = 70 msec	

Intercharacter Delay – cont.

START / END	
PROGRAMMING bar codes	
	Interchar Delay = 80 msec
Interchar Delay = 90 msec	

Software Flow Control

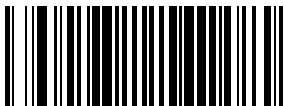

Disables/Enables software control using XON/XOFF characters.

START / END	
PROGRAMMING bar codes	
	Disable Software Flow Control DEFAULT
Enable Software Flow Control	

RS-232 Interface Features – cont.

Host Echo

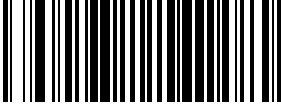
When enabled, this feature passes all data through the scanner to the host as it comes in. This feature is used for applications where “daisy chaining” of RS-232 devices onto the same cable is necessary. If, for example, one of the devices in the chain is a terminal where someone is entering data while another person is simultaneously scanning a bar code requiring transmission to the host, the scanner will wait for the RS-232 channel to be quiet for a specified period of time (set via *RS-232 Host Echo Quiet Interval*). The scanner can be set to observe this delay before sending its data in order to avoid RS-232 transmission conflicts.

START / END	
PROGRAMMING bar codes	
	Disable Host Echo DEFAULT
Enable Host Echo	





RS-232 Interface Features — cont.

Host Echo Quiet Interval

This setting specifies the time interval of RS-232 channel inactivity which must transpire before the scanner will break the host echo loop to transmit the bar code data that has just been scanned to the host.



START / END	
PROGRAMMING bar codes	
	Host Echo Quiet Interval = 0msec
Host Echo Quiet Interval = 10msec DEFAULT	
	Host Echo Quiet Interval = 20msec
Host Echo Quiet Interval = 30msec	
	Host Echo Quiet Interval = 40msec
Host Echo Quiet Interval = 50msec	
	Host Echo Quiet Interval = 60msec
Host Echo Quiet Interval = 70msec	

Host Echo Quiet Interval – cont.

START / END	
PROGRAMMING bar codes	
	Host Echo Quiet Interval = 80msec
Host Echo Quiet Interval = 90msec	
	Host Echo Quiet Interval = 100msec

Signal Voltage: Normal/TTL

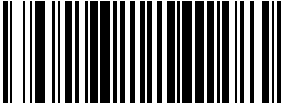
Specifies whether the RS-232 interface provides TTL levels on the output pins TxD and RTS.

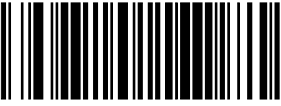
START / END	
PROGRAMMING bar codes	
	Signal Voltage: Normal RS-232 DEFAULT
Signal Voltage: TTL	



RS-232 Invert

Enables/disables inversion of RS-232 TXD and RXD signals.

START / END	
PROGRAMMING bar codes	
	Disable RS-232 Invert DEFAULT
Enable RS-232 Invert	

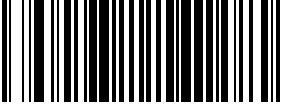

Beep on ASCII BEL

Enables/disables ability of scanner to beep (sound a good read tone) on receiving an ASCII BEL (07 hex).

START / END	
PROGRAMMING bar codes	
	Enable Beep on ASCII BEL DEFAULT
Disable Beep on ASCII BEL	

Beep on Not on File

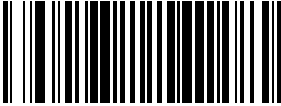



Select for the host to beep (or not) when a not-on-file (host command) condition is detected by the host.

START / END	
PROGRAMMING bar codes	
	Disable Beep on Not On File
Enable Beep on Not On File DEFAULT	

ACK NAK Options

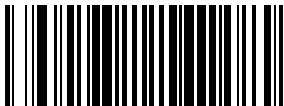
This enables/disables the ability of the scanner to support the RS-232 ACK/NAK protocol. When configured, the scanner and/or host sends an “ACK” when it receives data properly, and sends “NAK” when the data is in error. Selections for this option are:

- Disable
- Enable for label transmission — the scanner expects an ACK/NAK response from the host when a label is sent
- Enable for host-command acknowledge — the scanner will respond with ACK/NAK when the host sends a command
- Enable for label transmission and host-command acknowledge

START / END	
PROGRAMMING bar codes	
	Disable ACK NAK DEFAULT
Enable ACK NAK for Transmission	
	Enable ACK NAK for host command acknowledge
Enable ACK NAK for transmission and host command	

RS-232 Interface Features – cont.

ACK Character

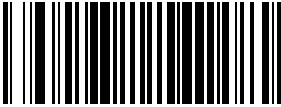
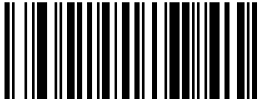
START / END	
PROGRAMMING bar codes	
<p>Sets the ACK character from the set of ASCII characters or any decimal value from 000 to 255. Pad entries of less than three digits with zeros, as in “005”. To configure this feature, scan the “START/END” bar code above to place the unit in Programming Mode, then the “Set ACK Character,” followed by the digits from the Alphanumeric table in Appendix C, Alpha-Numeric Pad representing your desired character. Exit programming mode by again scanning the “START/END” bar code above.</p> <p style="text-align: center;">DEFAULT SETTING FOR THIS FEATURE: 006</p>	
	Set ACK Character

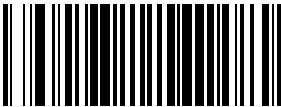
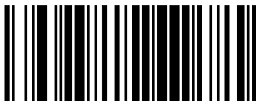

NAK Character

START / END	
PROGRAMMING bar codes	
<p>Sets the NAK character from the set of ASCII characters or any decimal value from 000 to 255. Pad entries of less than three digits with zeros, as in “005”. To configure this feature, scan the “START/END” bar code above to place the unit in Programming Mode, then the “Set NAK Character,” followed by the digits from the Alphanumeric table in Appendix C, Alpha-Numeric Pad representing your desired character. Exit programming mode by again scanning the “START/END” bar code above.</p> <p style="text-align: center;">DEFAULT SETTING FOR THIS FEATURE: 021</p>	
	Set NAK Character

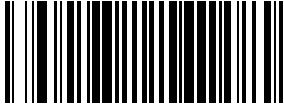

RS-232 Interface Features — cont.

Retry on ACK NAK Timeout

Enables/disables retry after the configurable ACK NAK Timeout Value (set in the following feature) has expired.

START / END	
PROGRAMMING bar codes	
	Disable Retry on ACK NAK Timeout
Enable Retry on ACK NAK Timeout DEFAULT	

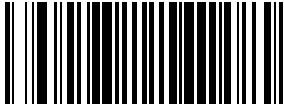
ACK NAK Timeout Value

START / END	
PROGRAMMING bar codes	
<p>This item specifies the time the scanner will wait for an ACK character from the host following a label transmission.</p> <p>00 = Infinite timeout 01 - 75 = Timeout in 200-millisecond increments</p> <p>To configure this feature, scan the “START/END” bar code above to place the unit in Programming Mode, then the “Set ACK NAK Timeout Value,” followed by the two digits (zero padded) from the Alphanumeric table in Appendix C, Alpha-Numeric Pad representing your desired value. Exit programming mode by again scanning the “START/END” bar code above.</p> <p style="text-align: center;">DEFAULT SETTING FOR THIS FEATURE: 01 (200 msec)</p>	
	Set ACK NAK Timeout Value

RS-232 Interface Features – cont.

ACK NAK Retry Count

START / END



PROGRAMMING bar codes

This feature sets the number of times for the scanner to retry a label transmission under a retry condition.

000 = No retry

001 - 254 = Retry for the specified number of times

255 = Retry forever

To configure this feature, scan the “START/END” bar code above to place the unit in Programming Mode, then the “Set ACK NAK Retry Count,” followed by the three digits (zero padded) from the Alphanumeric table in [Appendix C, Alpha-Numeric Pad](#) representing your desired retry count. Exit programming mode by again scanning the “START/END” bar code above

DEFAULT SETTING FOR THIS FEATURE: 003



Set ACK NAK Timeout Value

RS-232 Interface Features — cont.





ACK NAK Error Handling

This item specifies the method the scanner will use to handle errors detected while waiting to receive the ACK character from the host. Errors include unrecognized host commands and communication errors such as parity or framing errors. Choices are:

00 = Ignore errors detected (recommended setting)

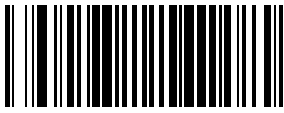
01 = Process error as valid ACK character (risk of lost label data)



02 = Process error as valid NAK character (risk of duplicate label data)

START / END	
PROGRAMMING bar codes	
	Ignore Errors Detected DEFAULT
Process error as valid ACK character	
	Process error as valid NAK character

RS-232 Interface Features – cont.

Transmission Failure Indication

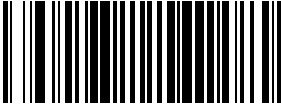
Enables/disables bad-label indication upon transmission failure.

START / END	
PROGRAMMING bar codes	
	Disable Transmission Error Indication
Enable Transmission Error Indication DEFAULT	

Single Cable RS-232

Single Cable RS-232 Options

The RS-232 Single Cable interface shares some configuration options with other RS-232 interfaces. Rather than repeat them in this section as Single Cable options, please find them referenced as follows:



- RS-232 Baud Rate on [page 43](#)
- RS-232 Number of Data Bits on [page 44](#)
- RS-232 Number of Stop Bits on [page 44](#)
- RS-232 Parity on [page 44](#)
- RS-232 Software Flow Control on [page 47](#)
- RS-232 Beep on Not on File on [page 52](#)
- RS-232 Label ID Control on [page 76](#)

Single Cable RS-232 RTS CTS Selection

Specifies how RTS and CTS are used to control the data flow. RTS is controlled by the Scanner and can be continuously held high/low, or can be asserted during label transmission. The scanner looks at CTS, as the configuration values state, to determine when to send label data.

Choices are:

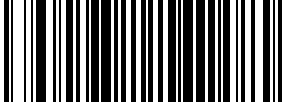
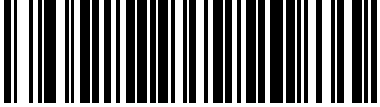
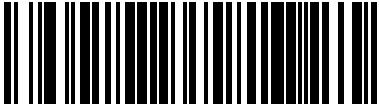
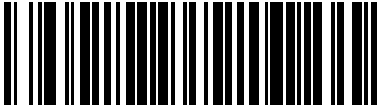
- Option 0 = RTS is held in low state and CTS is ignored
- Option 1 = RTS is held in high state and CTS is ignored
- Option 2 = Assert RTS and wait for CTS to be asserted
- Option 3 = Assert RTS and ignore CTS
- Option 4 = RTS held low, wait for CTS to be asserted
- Option 5 = RTS held high, wait for CTS to be asserted

START / END	
PROGRAMMING bar codes	
	RTS CTS Selection = RTS is held in low state and CTS is ignored
RTS CTS Selection = RTS is held in high state and CTS is ignored	
	RTS CTS Selection = Assert RTS and wait for CTS to be asserted
RTS CTS Selection = Assert RTS and ignore CTS	
	RTS CTS Selection = RTS held low, wait for CTS to be asserted
RTS CTS Selection = RTS held high, wait for CTS to be asserted DEFAULT	

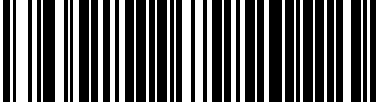
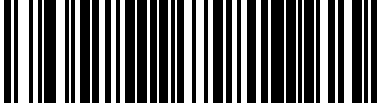

Single Cable RS-232 Use BCC

Enables/disables the ability of the scanner to use BCC.

START / END	
PROGRAMMING bar codes	
	Disable BCC
Enable BCC DEFAULT	

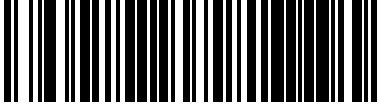

Single Cable RS-232 Use ACK/NAK

Enables/disables the ability of the scanner to use ACK/NAK.

START / END	
PROGRAMMING bar codes	
	Disable ACK/NAK
Enable ACK/NAK DEFAULT	

Single Cable RS-232 Use STX

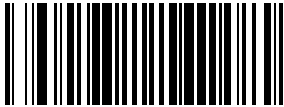
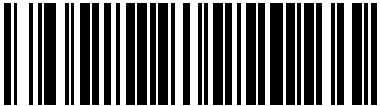
Enables/disables the ability of the scanner to use STX.

START / END	
PROGRAMMING bar codes	
	Disable STX
Enable STX DEFAULT	

Set Single Cable RS-232 STX Character

This feature selects the STX character.

To specify the STX Character:

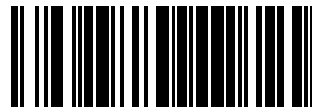

1. Scan the START/END bar code.
2. Scan the bar code, SET SINGLE CABLE RS-232 STX CHARACTER below. You'll need to cover any unused bar codes on this and the facing page to ensure the scanner reads only the bar code you intend to scan.
3. Scan the appropriate characters/digits from the keypad in [Appendix C](#) that represent the decimal designation for the desired character. A table containing the ASCII Character Set and their corresponding hex values is available in the inside back cover of this manual. ASCII parameters must be input by scanning decimal digits for each character. Pad all numbers with leading zeroes to yield a three-digit entry (001-127). Thus, to set a single character value of A, bar codes containing the digits '0', '6' and '5' must be scanned. The selectable range for this option is any decimal value from 001 to 127.
4. The scanner will automatically exit Programming Mode when the appropriate amount of digits have been scanned.



SET SINGLE CABLE RS-232 STX CHARACTER

Single Cable RS-232 Use ETX

Enables/disables the ability of the scanner to use ETX.

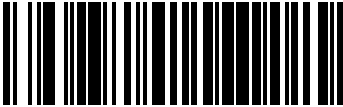
START / END	
PROGRAMMING bar codes	
	Disable ETX
Enable ETX DEFAULT	

Set Single Cable RS-232 ETX Character

Allows selection of the ETX character.

To specify the ETX Character:

1. Scan the START/END bar code.
2. Scan the bar code, SET SINGLE CABLE RS-232 ETX CHARACTER below. You'll need to cover any unused bar codes on this and the facing page to ensure the scanner reads only the bar code you intend to scan.
3. Scan the appropriate characters/digits from the keypad in [Appendix C](#) that represent the decimal designation for the desired character. A table containing the ASCII Character Set and their corresponding decimal values is available in the inside back cover of this manual. ASCII parameters must be input by scanning decimal digits for each character. Pad all numbers with leading zeroes to yield a three-digit entry (001-127). Thus, to set a single character value of A, bar codes containing the digits '0', '6' and '5' must be scanned. The selectable range for this option is any decimal value from 001 to 127.
4. The scanner will automatically exit Programming Mode when the appropriate amount of digits have been scanned.



SET SINGLE CABLE RS-232 ETX CHARACTER

Single Cable Pacesetter Plus

Enables/disables sending Pacesetter Plus information as trailers to UPC/EAN labels.

START / END	
PROGRAMMING bar codes	
	Disable Pacesetter Plus DEFAULT
Enable Pacesetter Plus	

Single Cable Datalogic Extensions

Enables Datalogic Scanning, Inc. extensions to the Single Cable RS-232 interface.



START / END	
PROGRAMMING bar codes	
	Disable Datalogic Extensions DEFAULT
Enable Datalogic Extensions	

USB-OEM Interface Features

USB-OEM Device usage

The USB-OEM protocol allows for the scanner to be identified as one of two different types of bar code scanners. Depending on what other scanners you may already have connected to a USB-OEM POS, you may need to change this setting to enable all devices to communicate. Options are:

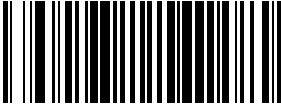
- Table Top Scanner
- Handheld Scanner

START / END	
PROGRAMMING bar codes	
	Configure as Table Top Scanner DEFAULT
Configure as Handheld Scanner	

IBM

IBM Transmit Labels in Code 39 Format

This feature enables/disables scanner's ability to set a symbology identifier for a specified label to Code 39 before transmitting that label data to an IBM host. This applies to: Code 128, Codabar and Code 93 for USB-OEM; Code 128, Codabar and Code 93 for IBM Port 5B; and Codabar and Code 93 for IBM Port 9B.

START / END	
PROGRAMMING bar codes	
	Disable Convert to Code 39 DEFAULT
Enable Convert to Code 39	

Keyboard Wedge and USB Keyboard

As a keyboard interface, the scanner supports most popular PCs and IBM terminals. The installation of the wedge is a fairly simple process that doesn't require any changes of software or hardware.



All of the options in this section apply to the Keyboard Wedge, however, only some apply to USB Keyboard.

NOTE

Keyboard Layout

The Keyboard Layout option supports many countries. For details about Keyboard Layout, please refer to your operating system manual.

START / END	
PROGRAMMING bar codes	
	USA DEFAULT
Belgium	
	Britain
Denmark	
	France
Germany	

Keyboard Wedge – cont.



START / END	
PROGRAMMING bar codes	
	Italy
Norway	
	Portugal
Spain	
	Sweden
Switzerland	
	Japan 106 Key
Hungary	
	Czech Republic

Keyboard Wedge – cont.

START / END	
PROGRAMMING bar codes	
	Slovakia
Romania	
	Croatia
Poland	

Caps Lock State

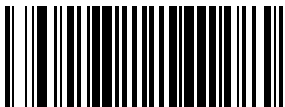
Specifies the format in which the scanner sends character data.

START / END	
PROGRAMMING bar codes	
	Disable Caps Lock DEFAULT
Caps Lock "ON"	
	Shift Lock "ON"

Keyboard Wedge – cont.



Power-On Simulation



This feature does not apply to the USB Keyboard interface.

NOTE



All PCs check the keyboard status during the power-on Selftest. It is recommended that you enable this function if you are working without a keyboard installation. It simulates keyboard timing and passes the keyboard status to the PC during power-on.

START / END	
PROGRAMMING bar codes	
	Disable Power-on Simulation DEFAULT
Enable Power-on Simulation	

Control Characters

Specifies how the scanner transmits ASCII control characters to the host. Choices are:

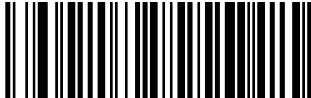
- Disable Control Characters
- Enable transmission of control characters to host
- Send characters between 00H and 1FH according to a special function-key mapping table. (This is used to send keys that are not in the normal ASCII set; a unique set is provided for each available scancode set. Reference [Appendix E, Keyboard Function Key Mappings.](#))

START / END	
PROGRAMMING bar codes	
	Disable Control Characters DEFAULT
Enable Transmission of Control Characters	
	Enable Function Key Mapping

Keyboard Wedge – cont.



Wedge Quiet Interval



NOTE



This feature does not apply to the USB Keyboard interface.

Quiet Interval is the amount of time to look for keyboard activity before the scanner breaks the keyboard connection in order to transmit data to the host.

START / END	
PROGRAMMING bar codes	
Selectable from 001 to 100 in 10 msec increments. To configure this feature, scan the “START/END” bar code above to place the unit in Programming Mode, then the Set Wedge Quiet Interval bar code followed by the three digits (zero padded) from the Alphabetic table in Appendix C, Alpha-Numeric Pad representing your desired length. Exit programming mode by again scanning the “START/END” bar code above.	
<p style="text-align: center;">DEFAULT SETTING FOR THIS FEATURE: 010 (100 msec)</p>	
	Set Wedge Quiet Interval

Keyboard Wedge – cont.

Intercharacter Delay

START / END	
PROGRAMMING bar codes	
<p>One-half of the delay specified below is inserted between scancodes within each character. If the transmission speed is too high, the system may not be able to receive all characters. You may need to adjust the delay to make the system work properly. Selectable from 00 to 99 in 10msec increments.</p> <p>To configure this feature, scan the “START/END” bar code above to place the unit in Programming Mode, then the “Set Intercharacter Delay,” followed by the two digits (zero padded) from the Alphanumeric table in Appendix C, Alpha-Numeric Pad representing your desired length. Exit programming mode by again scanning the “START/END” bar code above/</p> <p style="text-align: center;">DEFAULT SETTING FOR THIS FEATURE: 00 (No Delay)</p>	
	Set Intercharacter Delay

USB COM Interface Set-up

The scanner has two USB COM interfaces, USB COM and USB COM DL (Datalogic). The Datalogic USB-COM driver works for both USB COM interfaces.

Before plugging your scanner into the Host PC, please ensure you have already copied the executable DLS-USB-COM driver file to your PC and that the scanner’s interface is set to USB COM or USB COM DL. The DLS-USB-COM driver is provided by Datalogic or downloaded from the Datalogic Scanning website listed on the back cover of this manual.

1. Execute the DLS-USB-COM driver file.
2. When the scanner is first plugged into the PC, Windows will bring up the “Found New Hardware” message.
3. The installation is complete.

NOTES

Chapter 5

Data Editing

Data Editing Overview



CAUTION

It is not recommended to use these features with IBM interfaces.

When a bar code is scanned, additional information can be sent to the host computer along with the bar code data. This combination of bar code data and supplementary user-defined data is called a “message string.” The features in this chapter can be used to build specific user-defined data into a message string.

There are several types of selectable data characters that can be sent before and after scanned data. You can specify if they should be sent with all symbologies, or only with specific symbologies. [Figure 1](#) shows the available elements you can add to a message string:

Figure 1. Breakdown of a Message String

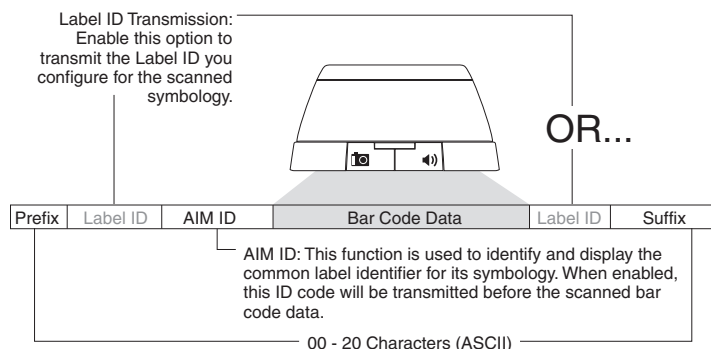



Please Keep In Mind...

- Modifying a message string is not a mandatory requirement. Data editing is sophisticated feature allowing highly customizable output for advanced users. Factory default settings for data editing is typically set to NONE.
- A prefix or suffix may be applied (reference the [Symbologies](#) chapter for these settings) across all symbologies (set via the Global features in this chapter).
- You can add any character from the [ASCII Chart](#) (from 00-FF) on the inside back cover of this manual as a prefix, suffix or Label ID.
- Enter prefixes and suffixes in the order in which you want them to appear on the output.

Global Prefix/Suffix

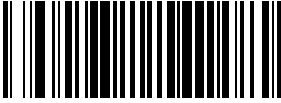
Up to 20 ASCII characters may be added as a prefix (in a position before the bar code data) and/or as a suffix (in a position following the bar code data).

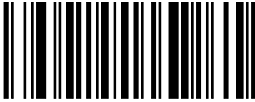
START / END	
PROGRAMMING bar codes	
<p>Sets up to 20 characters each from the set of ASCII characters or any hex value from 00 to FF. To configure this feature, scan the "START/END" bar code above to place the unit in Programming Mode, then the "Set Prefix" or "Set Suffix," followed by the digits from the Alphanumeric table in Appendix C, Alpha-Numeric Pad representing your desired character(s). Reference the section, Example: Setting a Prefix on page 152, for more information. Exit programming mode by scanning the "START/END" bar code again (scan "START/END" twice if less than 20 characters have been selected).</p> <p style="text-align: center;">DEFAULT SETTING PREFIX: 00 (None) DEFAULT SETTING SUFFIX: 0D (CR)</p>	
	Set Prefix
Set Suffix	

AIM ID

AIM (Automatic Identification Manufacturers) label identifiers are assigned from a globally standardized list — as opposed to custom label ID characters you select yourself — and can be included with scanned bar code data. AIM label identifiers consist of three characters as follows:

- A close brace character (ASCII '['), followed by...
- A code character (see the table below), followed by...
- A modifier character (the modifier character is symbol dependent)

SYMBOLGY	CHAR	SYMBOLGY	CHAR
UPC/EAN	E	Code 128/EAN 128	C
Code 39	A	GS1 Omnidirectional, GS1 Expanded	e
Codabar	F	Standard 2 of 5	S
Interleaved 2 of 5	I	ISBN	X ^a
Code 93	G		

a. ISBN (X with a 0 modifier character)

Figure 2. AIM ID

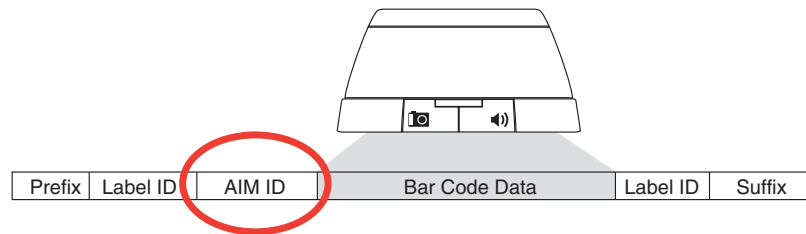

START / END	
PROGRAMMING bar codes	
	Disable AIM ID DEFAULT
Enable AIM ID	

Label ID

See [Label ID on page 153](#) for more information on setting this feature.

START / END	
PROGRAMMING bar codes	
	Label ID Transmission: Disable
Label ID Position	
Label ID Position: Before Bar Code Data DEFAULT	
	Label ID Position: After Bar Code Data
Set UPC-A Label ID Character(s)	 DEFAULT SETTING FOR THIS FEATURE: A (41 hex)
 DEFAULT SETTING FOR THIS FEATURE: A (41 hex)	Set UPC-A w/P2 Addon Label ID Character(s)
Set UPC-A w/P5 Addon Label ID Character(s)	 DEFAULT SETTING FOR THIS FEATURE: A (41 hex)
 DEFAULT SETTING FOR THIS FEATURE: A (41 hex)	Set UPC-A w/C128 Addon Label ID Character(s)
Set UPC-E Label ID Character(s)	 DEFAULT SETTING FOR THIS FEATURE: E (45 hex)

Label ID — cont.

START / END	
PROGRAMMING bar codes	
 DEFAULT SETTING FOR THIS FEATURE: E (45 hex)	Set UPC-E w/P2 Addon Label ID Character(s)
Set UPC-E w/P5 Addon Label ID Character(s)	 DEFAULT SETTING FOR THIS FEATURE: E (45 hex)
 DEFAULT SETTING FOR THIS FEATURE: E (45 hex)	Set UPC-E w/C128 Addon Label ID Character(s)
Set EAN-8 Label ID Character(s)	 DEFAULT SETTING FOR THIS FEATURE: FF (4646 hex)
 DEFAULT SETTING FOR THIS FEATURE: FF (4646 hex)	Set EAN-8 w/P2 Addon Label ID Character(s)
Set EAN-8 w/P5 Addon Label ID Character(s)	 DEFAULT SETTING FOR THIS FEATURE: FF (4646 hex)
 DEFAULT SETTING FOR THIS FEATURE: FF (4646 hex)	Set EAN-8 w/C128 Addon Label ID Character(s)
Set EAN-13 Label ID Character(s)	 DEFAULT SETTING FOR THIS FEATURE: F (46 hex)

Label ID — cont.

START / END	
PROGRAMMING bar codes	
 DEFAULT SETTING FOR THIS FEATURE: F (46 hex)	Set EAN-13 w/P2 Addon Label ID Character(s)
Set EAN-13 w/P5 Addon Label ID Character(s)	 DEFAULT SETTING FOR THIS FEATURE: F (46 hex)
 DEFAULT SETTING FOR THIS FEATURE: F (46 hex)	Set EAN-13 w/C128 Addon Label ID Character(s)
Set ISBN Label ID Character(s)	 DEFAULT SETTING FOR THIS FEATURE: I (49 hex)
 DEFAULT SETTING FOR THIS FEATURE: IA (4941 hex)	Set IATA Label ID Character(s)
Set GTIN Label ID Character(s)	 DEFAULT SETTING FOR THIS FEATURE: G (47 hex)
 DEFAULT SETTING FOR THIS FEATURE: G2 (4732 hex)	Set GTIN w/P2 addon Label ID Character(s)
Set GTIN w/P5 addon Label ID Character(s)	 DEFAULT SETTING FOR THIS FEATURE: G5 (4735 hex)

Label ID — cont.

START / END	
PROGRAMMING bar codes	
 DEFAULT SETTING FOR THIS FEATURE: G8 (4738 hex)	Set GTIN w/C128 addon Label ID Character(s)
Set GS1 Omnidirectional Label ID Character(s)	 DEFAULT SETTING FOR THIS FEATURE: R4 (5234 hex)
 DEFAULT SETTING FOR THIS FEATURE: RX (5258 hex)	Set GS1 Expanded Label ID Character(s)
Set Code GS1 DataBar Limited Label ID Character(s)	 DEFAULT SETTING FOR THIS FEATURE: * (524C0000 hex)
 DEFAULT SETTING FOR THIS FEATURE: * (2A hex)	Set Code 39 Label ID Character(s)
Set Pharmacode 39 Label ID Character(s)	 DEFAULT SETTING FOR THIS FEATURE: A (41 hex)
 DEFAULT SETTING FOR THIS FEATURE: # (23 hex)	Set Code 128 Label ID Character(s)
Set I 2 of 5 Label ID Character(s)	 DEFAULT SETTING FOR THIS FEATURE: i (69 hex)

Label ID — cont.

START / END		
PROGRAMMING bar codes		
	Set Codabar Label ID Character(s)	
DEFAULT SETTING FOR THIS FEATURE: % (25 hex)		
Set Code 93 Label ID Character(s)		
DEFAULT SETTING FOR THIS FEATURE: & (26 hex)		
	Set Code 11 Label ID Character(s)	
DEFAULT SETTING FOR THIS FEATURE: @ (40 hex)		
Set EAN UCC Composite Label ID Character(s)		
DEFAULT SETTING FOR THIS FEATURE: 0		
	Set PDF 417 Label ID Character(s)	
DEFAULT SETTING FOR THIS FEATURE: P (5000 hex)^a		
Set Datamatrix Label ID Character(s)		
DEFAULT SETTING FOR THIS FEATURE: Dm (446D hex)		
	Set MSI Label ID Character(s)	
DEFAULT SETTING FOR THIS FEATURE: @ (40 hex)		

a.

Default setting exceptions for PDF 417 Label ID are as follows: Default for RS-232 WN is 'Q' (0x5100). Default for USB-HID-POS is 'P' (0x5020), or 'P-Space'.

Label ID — cont.



For the 2D symbologies on this page, the Label ID is 4 bytes. The first 3 bytes are characters for the label ID. A 00 (hex) value in the first 3 bytes indicates the end of the label ID characters. The 4th byte is a control byte.

NOTE

The use of the control byte is as follows:
bit 0-if set to 1, the AIM ID is appended for that label type

START / END	
PROGRAMMING bar codes	
	Set Micro PDF 417 Label ID Character(s)
DEFAULT SETTING FOR THIS FEATURE: mP (6D500000 hex)	
Set QR Code Label ID Character(s)	
DEFAULT SETTING FOR THIS FEATURE: QR (51520000 hex)	
	Set Maxicode Label ID Character(s)
DEFAULT SETTING FOR THIS FEATURE: MC (4D430000 hex)	
Set Aztec Label ID Character(s)	
DEFAULT SETTING FOR THIS FEATURE: Az (417A0000 hex)	
	Set GS1 DataBar Omnidirectional 2D Composite Label ID Character(s)
DEFAULT SETTING FOR THIS FEATURE: R4 (52340000 hex)	
Set GS1 DataBar Limited 2D Composite Label ID Character(s)	
DEFAULT SETTING FOR THIS FEATURE: RL (524C0000 hex)	
	Set GS1 DataBar Expanded 2D Composite Label ID Character(s)
DEFAULT SETTING FOR THIS FEATURE: RX (52340000 hex)	





Case Conversion

This feature can convert scanned bar code data to either all lower case (a through z) or all upper case (A through Z) characters.



NOTE

Case conversion affects ONLY scanned bar code data, and does not affect Label ID, Prefix, Suffix, or other appended data.

START / END	
PROGRAMMING bar codes	
	Disable DEFAULT
Convert to Upper Case	
	Convert to Lower Case

Character Conversion

Character conversion is an eight byte configuration item. The eight bytes are 4 character pairs represented in hexadecimal ASCII values. The first character in the pair is the character that will be converted. The second character in the pair is the character to convert to. If the character to convert in a pair is **FE**, then no conversion is done.

For example, if you have the character conversion configuration item set to the following:

41423132FFFFFFFF

The first pair is **4142** or AB (**41** hex is an ASCII capital A, **42** hex is an ASCII capital B) and the second pair is **3132** or 12 (**31** hex is an ASCII 1, **32** is an ASCII 2). The other two pairs are **FFFF** and **FFFF**.

With the label, AG15TA81, it would look as follows after the character conversion:
BG25TB82.

The A characters were converted to the B character and the 1 characters were converted to the numeral 2 character. Nothing is done with the last two character pairs, since they are all **FE**.

To set Character Conversion:



1. Scan the START/END bar code.
2. Scan the Character Conversion bar code.
3. Determine the desired string. Up to sixteen positions can be determined as in the above example. Next, turn to the [ASCII Chart](#) on the inside back cover of this manual and find the equivalent hex digits needed to fulfill the string.



The positions not used must be filled with the character 'F'.

NOTE

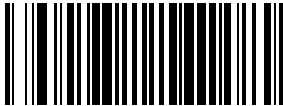
4. Turn to [Appendix C, Alpha-Numeric Pad](#) and scan the bar codes representing the hex characters determined in the previous step. When the last character is scanned, the scanner will sound a triple beep.
5. Scan the START/END bar code to exit Programming Mode.

START / END	
PROGRAMMING bar codes	
	Character Conversion
DEFAULT SETTING FOR THIS FEATURE: FFFFFFFFFFFFFFFF hex (no conversion)	

NOTES

Chapter 6

Symbologies

The scanner supports the following symbologies (bar code types). Options for each symbology are included in this chapter.



- UPC-A
- UPC-E
- EAN-13
- EAN-8
- GS1 DataBar Omnidirectional / Stacked Omnidirectional
- GS1 DataBar Expanded / Expanded Stacked
- GS1 DataBar Limited
- Code 39
- Code 32 Italian Pharmacode
- Code 128
- Interleaved 2 of 5
- Codabar
- Code 93
- MSI

Factory Defaults— for the standard RS-232 interface are indicated in bold text throughout this section. Reference [Appendix D, Factory Default Settings](#) for default exceptions for your interface.

UPC-A

Disable/Enable UPC-A

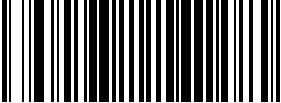

When disabled, the scanner will not read UPC-A bar codes.

START / END	
PROGRAMMING bar codes	
	Disable UPC-A
Enable UPC-A DEFAULT	

UPC-A — cont.

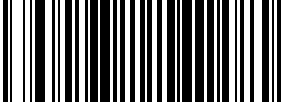

Check Digit Transmission

Enable this option to transmit the check digit along with UPC-A bar code data.

START / END	
PROGRAMMING bar codes	
	Don't Send Check Digit
Send Check Digit DEFAULT	

Number System Transmission

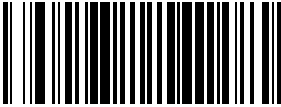

This feature enables/disables transmission of UPC-A System Number.

START / END	
PROGRAMMING bar codes	
	Disable Number System Transmission
Enable Number System Transmission DEFAULT	

UPC-A — cont.

Expand UPC-A to EAN-13

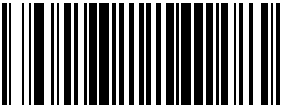
Expands UPC-A data to the EAN-13 data format. Selecting this feature also changes the symbology ID to match those required for EAN-13.



START / END	
PROGRAMMING bar codes	
	Don't Expand to EAN-13 DEFAULT
Expand to EAN-13	

UPC-E

The following options apply to the UPC-E symbology.

Disable/Enable UPC-E

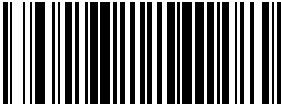
When disabled, the scanner will not read UPC-E bar codes.

START / END	
PROGRAMMING bar codes	
	Disable UPC-E
Enable UPC-E DEFAULT	

Check Digit Transmission



Enable this option to transmit the check digit along with UPC-E bar code data.

START / END	
PROGRAMMING bar codes	
	Don't Send Check Digit
Send Check Digit DEFAULT	

UPC-E — cont.

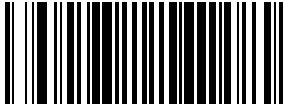

Number System Digit

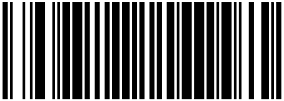
The Number System Digit (NSD) which is always a zero (0) in the leading position can be optionally included (or not) with scanned bar code data.

START / END	
PROGRAMMING bar codes	
	Exclude Number System Digit DEFAULT
Include Number System Digit	

Expand to UPC-E to UPC-A

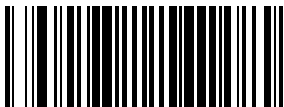

Enables/disables expansion of UPC-E labels to UPC-A. Selecting this feature also changes the symbology ID to match those required for UPC-A.

START / END	
PROGRAMMING bar codes	
	Don't Expand UPC-E to UPC-A DEFAULT
Expand UPC-E to UPC-A	

UPC-E — cont.

Expand UPC-E to EAN13

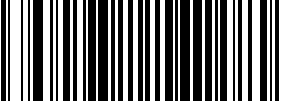
Enables/disables expansion of UPC-E labels to EAN-13. Selecting this feature also changes the symbology ID to match those required for EAN-13.



START / END	
PROGRAMMING bar codes	
	Don't Expand UPC-E to EAN-13 DEFAULT
Expand UPC-E to EAN-13	

GTIN

The following options apply to the GTIN label data format.

Expand UPC/EAN to GTIN

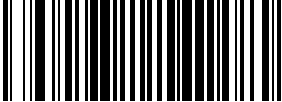
When this feature is enabled, the scanner will translate UPC/EAN labels to the 14 digit GTIN format.



START / END	
PROGRAMMING bar codes	
	Don't Expand to GTIN DEFAULT
Expand to GTIN	

EAN-13

The following options apply to the EAN-13 symbology.

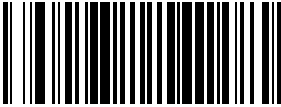

Disable/Enable EAN-13

When disabled, the scanner will not read EAN-13 bar codes.

START / END	
PROGRAMMING bar codes	
	Disable EAN-13
Enable EAN-13 DEFAULT	

Check Digit Transmission

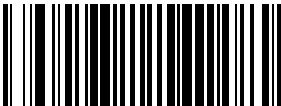

Enable this option to transmit the check digit along with EAN-13 bar code data.

START / END	
PROGRAMMING bar codes	
	Don't Send Check Digit
Send Check Digit DEFAULT	

EAN-13 — cont.

EAN-13 Flag 1 Character

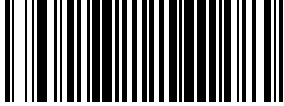
Enables/disables transmission of an EAN/JAN13 Flag1 character.

START / END	
PROGRAMMING bar codes	
	Don't Transmit EAN-13 Flag 1 Char
Transmit EAN-13 Flag 1 Char DEFAULT	

ISBN

When enabled, this feature truncates the leading three digits from labels that contain ISBN (International Standard Book Number) and appends an ISBN check character to the end of the label. These codes are used for books and magazines. Labels with ISBN codes start with "978".

Example:

Bar Code data: "9789572222720"

Output: "9572222724"

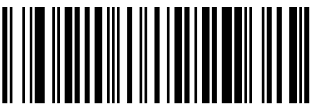

START / END	
PROGRAMMING bar codes	
	Disable ISBN DEFAULT
Enable ISBN	

EAN-8

The following options apply to the EAN-8 symbology.

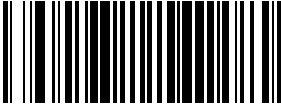

Disable/Enable EAN-8

When disabled, the scanner will not read EAN-8 bar codes.

START / END	
PROGRAMMING bar codes	
	Disable EAN-8
Enable EAN-8 DEFAULT	



Check Digit Transmission

Enable this option to transmit the check Digit along with EAN-8 bar code data.

START / END	
PROGRAMMING bar codes	
	Don't Send Check Digit
Send Check Digit DEFAULT	

EAN-8 — continued

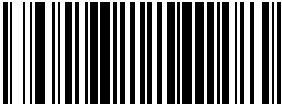
Expand EAN-8 to EAN-13— Expands EAN-8 data to the EAN-13 data format. Selecting this feature also changes the symbology ID to match those required for EAN-13.

START / END	
PROGRAMMING bar codes	
	Don't Expand to EAN-13 DEFAULT
Expand to EAN-13	

EAN Two-Label

Enables/disables the ability of the scanner to decode EAN two-label pairs.

START / END	
PROGRAMMING bar codes	
	Disable EAN Two-Label
Enable EAN Two-Label	

EAN Two-Label Combined Transmission

Enables/disables the transmitting of an EAN two label pair as one label.

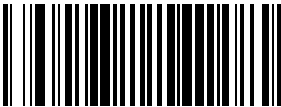
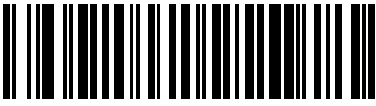
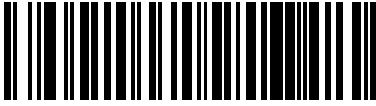
START / END	
PROGRAMMING bar codes	
	EAN Two-Label Combined Transmission = Disable DEFAULT
EAN Two-Label Combined Transmission = Enable	

Price Weight Check Digit

Enables/disables calculation and verification of price/weight check digits.



Applies to all UPC-A labels with a number-system character of 2 and EAN/JAN 13 labels with a

NOTE

1 digit of 2

Here are the available options for this feature:

- Disable
- Enable 4-digit price/wt check-digit calculation
- Enable 5-digit price/wt check-digit calculation
- Enable European 4-digit price-weight check-digit calculation
- Enable European 5-digit price-weight check-digit calculation

START / END	
PROGRAMMING bar codes	
	Price Weight Check Digit = Disable DEFAULT
Price Weight Check Digit = Enable 4-digit price/wt	
	Price Weight Check Digit = Enable 5-digit price/wt
Price Weight Check Digit = Enable European 4-digit price/wt	
	Price Weight Check Digit = Enable European 5-digit price/wt

Add-ons

Add-ons (or supplemental characters) are commonly added to the end of UPC/EAN bar codes. The scanner will read the add-ons if they are enabled and in the field of view. Three add-on types are supported: 2-digit, 5-digit and Code 128 add-ons. Supported options are:

None— This option directs the scanner to ignore add-on portion of a UPC/EAN bar code but still read the main portion of the bar code.

2 Digits— The scanner will optionally read 2-digit add-ons with the UPC/EAN label.

5 Digits— The scanner will optionally read 5-digit add-ons with the UPC/EAN label.

Code 128 Add-on— The scanner will optionally read Code 128 add-ons with the UPC/EAN label.



Contact Customer Support for advanced programming of optional and conditional add-ons.

NOTE

Add-ons — continued



START / END	
PROGRAMMING bar codes	
	Disable Optional 2-Digit Add-ons DEFAULT
Enable Optional 2-Digit Add-ons	
	Disable Optional 5-Digit Add-ons DEFAULT
Enable Optional 5-Digit Add-ons	
	Disable Optional Code 128 Add-ons DEFAULT
Enable Optional Code 128 Add-ons	

GS1 DataBar Omnidirectional / Stacked Omnidirectional

The following options apply to the GS1 DataBar Omnidirectional symbology.



Disable/Enable GS1 DataBar Omnidirectional

When this feature is disabled, the scanner will not read GS1 DataBar Omnidirectional bar codes.

START / END	
PROGRAMMING bar codes	
	Disable GS1 DataBar Omnidirectional DEFAULT
Enable GS1 DataBar Omnidirectional	

UCC/EAN 128 Emulation

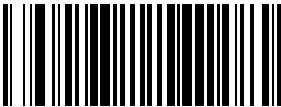
When enabled, GS1 DataBar Omnidirectional bar codes will be translated to the UCC/EAN 128 label data format.



START / END	
PROGRAMMING bar codes	
	Disable UCC/EAN 128 Emulation DEFAULT
Enable UCC/EAN 128 Emulation	

GS1 DataBar Expanded / Expanded Stacked

The following options apply to the GS1 DataBar Expanded symbology.

Disable/Enable GS1 DataBar Expanded

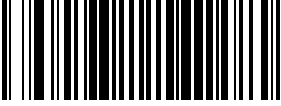
When this feature is disabled, the scanner will not read GS1 DataBar Expanded bar codes.

START / END	
PROGRAMMING bar codes	
	Disable GS1 DataBar Expanded DEFAULT
Enable GS1 DataBar Expanded	

GS1-128 Emulation

When enabled, GS1 DataBar Expanded bar codes will be translated to the GS1-128 label data format.

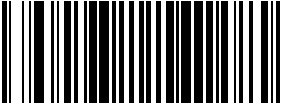
START / END	
PROGRAMMING bar codes	
	Disable GS1-128 Emulation DEFAULT
Enable GS1-128 Emulation	

GS1 DataBar Expanded / Expanded Stacked — continued

Length Control

Fixed Length Decoding— When fixed length decoding is enabled, the scanner will decode a bar code if the label length matches one of the configurable fixed lengths.

Variable Length Decoding— When variable length decoding is enabled, the scanner will decode a bar code if the label length falls in the range of the configurable Length 1 and Length 2 values.

START / END	
PROGRAMMING bar codes	
	Variable Length Decoding DEFAULT
Fixed Length Decoding	



GS1 DataBar Expanded Length 1, Length 2 Programming Instructions

See [Length 1, Length 2 Programming Instructions on page 154](#) for detailed instructions on setting this feature.



NOTE

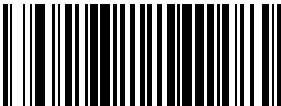

For GS1 DataBar Expanded bar codes, only the data characters are included in the length calculations.

START / END	
PROGRAMMING bar codes	
 DEFAULT SETTING FOR THIS FEATURE: 01	Set Length 1
Set Length 2	 DEFAULT SETTING FOR THIS FEATURE: 74

GS1 DataBar Expanded / Expanded Stacked — continued

Coupon Read Control

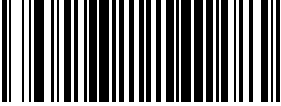
This feature controls coupon reading.

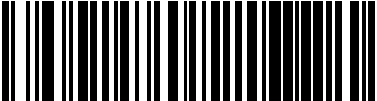
START / END	
PROGRAMMING bar codes	
	Disable coupon filtering
Enable UPCA coupon decoding Disable GS1 DataBar coupon decoding DEFAULT	
	Enable GS1 DataBar coupon decoding Disable UPCA coupon decoding

GS1 DataBar Limited

The following options apply to the GS1 DataBar Limited symbology.

Disable/Enable GS1 DataBar Limited

When this feature is disabled, the scanner will not read GS1 DataBar Limited bar codes.

START / END	
PROGRAMMING bar codes	
	Disable GS1 DataBar Limited DEFAULT
Enable GS1 DataBar Limited	

GS1-128 Emulation

When enabled, GS1 DataBar Limited bar codes will be translated to the GS1-128 label data format.

START / END	
PROGRAMMING bar codes	
	Disable GS1-128 Emulation DEFAULT
Enable GS1-128 Emulation	

Code 39

The following options apply to the Code 39 symbology.



Disable/Enable Code 39

When this feature is disabled, the scanner will not read Code 39 bar codes.

START / END	
PROGRAMMING bar codes	
	Disable Code 39
Enable Code 39 DEFAULT	

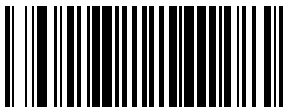

Check Character Calculation

When enabled, the scanner will calculate the check character of the labels. Turn this option on only when a checksum is present in the Code 39 labels.

START / END	
PROGRAMMING bar codes	
	Disable Check Char Calculation DEFAULT
Enable Check Char Calculation	



Check Character Transmit

Enable this option to transmit the check character with scanned bar code data.

START / END	
PROGRAMMING bar codes	
	Disable Check Char Transmission
Enable Check Char Transmission DEFAULT	

Start/Stop Characters

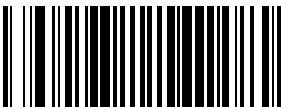
Enables/disables transmission of Code39 start and stop characters.

START / END	
PROGRAMMING bar codes	
	Don't Transmit Start/Stop Characters DEFAULT
Transmit Start/Stop Characters	

Code 39 Full ASCII

Enables/disables the translation of Code 39 characters to Code 39 full-ASCII characters.



START / END	
PROGRAMMING bar codes	
	Disable Code 39 Full ASCII DEFAULT
Enable Code 39 Full ASCII	

Code 39 — continued

Length Control

Fixed Length Decoding— When fixed length decoding is enabled, the scanner will decode a bar code if the label length matches one of the configurable fixed lengths.

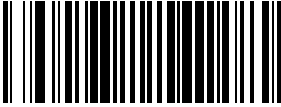
Variable Length Decoding— When variable length decoding is enabled, the scanner will decode a bar code if the label length falls in the range of the configurable Length 1 and Length 2 values.

START / END	
PROGRAMMING bar codes	
	Variable Length Decoding DEFAULT
Fixed Length Decoding	



Code 39 Length 1, Length 2 Programming Instructions

See [Length 1, Length 2 Programming Instructions](#) on page 154 for detailed instructions on setting this feature.

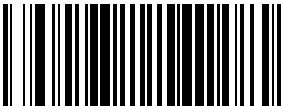
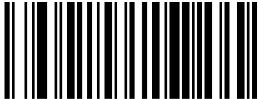

NOTE

For Code 39 bar codes, all check, data and full ASCII shift characters are included in the length calculations. Start/Stop characters are not included.



START / END	
PROGRAMMING bar codes	
 DEFAULT SETTING FOR THIS FEATURE: 02	Set Length 1
Set Length 2	 DEFAULT SETTING FOR THIS FEATURE: 50

Code 32 Italian Pharmacode

The following options apply to the Code 32 Italian Pharmacode symbology.

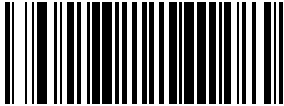
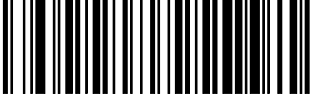

Disable/Enable Code 32 Italian Pharmacode

When this feature is disabled, the scanner will not read Code 32 Italian Pharmacode bar codes.

START / END	
PROGRAMMING bar codes	
	Disable Code 32 Italian Pharmacode DEFAULT
Enable Code 32 Italian Pharmacode	

Start/Stop Characters

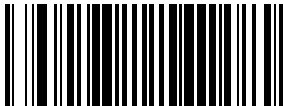
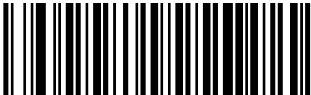

Enables or disables transmission of Code 32 Italian Pharmacode start/stop characters.

START / END	
PROGRAMMING bar codes	
	Don't Transmit Start/Stop Characters DEFAULT
Transmit Start/Stop Characters	

Code 32 Italian Pharmacode – continued

Check Character Transmit

Enable this option to transmit the check character with scanned bar code data.



START / END	
PROGRAMMING bar codes	
	Disable Check Char Transmission
Enable Check Char Transmission DEFAULT	

Code 128

The following options apply to the Code 128 symbology.

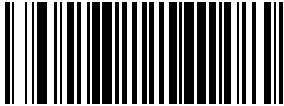

Disable/Enable Code 128

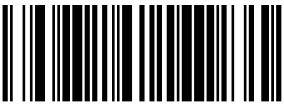
When this feature is disabled, the scanner will not read Code 128 bar codes.

START / END	
PROGRAMMING bar codes	
	Disable Code 128
Enable Code 128 DEFAULT	

Disable/Enable EAN 128

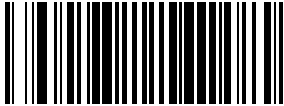
When this feature is disabled, the scanner will not read EAN 128 bar codes.

START / END	
PROGRAMMING bar codes	
	Disable EAN 128
Enable EAN 128 DEFAULT	

Code 128 — continued

Transmit Function Characters

Enables/disables transmission of Code 128 function characters 1, 2, 3, and 4.
Function codes are transmitted as follows:

- FNC1 = 80 hex
- FNC2 = 81 hex
- FNC3 = 82 hex
- FNC4 = 83 hex

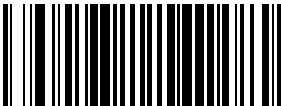
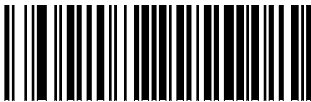
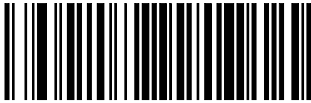

START / END	
PROGRAMMING bar codes	
	Don't Transmit Function Characters DEFAULT
Transmit Function Characters	

Code 128 — continued

Length Control

Fixed Length Decoding— When fixed length decoding is enabled, the scanner will decode a bar code if the label length matches one of the configurable fixed lengths.

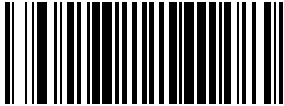
Variable Length Decoding— When variable length decoding is enabled, the scanner will decode a bar code if the label length falls in the range of the configurable Length 1 and Length 2 values.

START / END	
PROGRAMMING bar codes	
	Variable Length Decoding DEFAULT
Fixed Length Decoding	



Code 128 Length 1, Length 2 Programming Instructions

See [Length 1, Length 2 Programming Instructions on page 154](#) for detailed instructions on setting this feature.



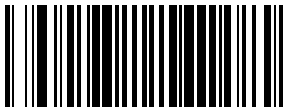

For Code 128 bar codes, only the data characters are included in the length calculations.

NOTE

START / END	
PROGRAMMING bar codes	
	Set Length 1
DEFAULT SETTING FOR THIS FEATURE: 01	
Set Length 2	
DEFAULT SETTING FOR THIS FEATURE: 80	

Code 128 Conversion to Code 39

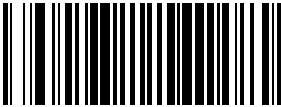
Enables/disables expansion of Code 128 labels to Code 39.

START / END	
PROGRAMMING bar codes	
	Disable DEFAULT
Enable	

Interleaved 2 of 5

The following options apply to the Interleaved 2 of 5 (I 2 of 5) symbology.



Disable/Enable Interleaved 2 of 5

When this feature is disabled, the scanner will not read Interleaved 2 of 5 bar codes.

START / END	
PROGRAMMING bar codes	
	Disable Interleaved 2 of 5 DEFAULT
Enable Interleaved 2 of 5	



Check Digit Calculation

When enabled, the scanner will calculate the check digit of the labels.

START / END	
PROGRAMMING bar codes	
	Disable Check Digit Calculation DEFAULT
Enable Check Digit Calculation	

Check Digit Transmit

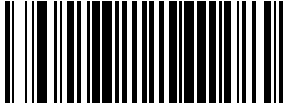
Enable this option to transmit the check digit with scanned bar code data.



START / END	
PROGRAMMING bar codes	
	Disable Check Digit Calculation DEFAULT
Enable Check Digit Calculation	

Interleaved 2 of 5 — continued

Length Control

Fixed Length Decoding— When fixed length decoding is enabled, the scanner will decode a bar code if the label length matches one of the configurable fixed lengths.

Variable Length Decoding— When variable length decoding is enabled, the scanner will decode a bar code if the label length falls in the range of the configurable Length 1 and Length 2 values.

START / END	
PROGRAMMING bar codes	
	Variable Length Decoding DEFAULT
Fixed Length Decoding	



Interleaved 2 of 5 Length 1, Length 2 Programming Instructions

See [Length 1, Length 2 Programming Instructions on page 154](#) for detailed instructions on setting this feature.



NOTE

For Interleaved 2 of 5 bar codes, lengths must be an even number. Additionally, all check and data characters are included in the length calculations.



START / END	
PROGRAMMING bar codes	
 DEFAULT SETTING FOR THIS FEATURE: 06	Set Length 1
Set Length 2	 DEFAULT SETTING FOR THIS FEATURE: 50

Codabar

The following options apply to the Codabar symbology.



Disable/Enable Codabar

When this feature is disabled, the scanner will not read Codabar bar codes.

START / END	
PROGRAMMING bar codes	
	Disable Codabar DEFAULT
Enable Codabar	



Check Character Verification

When enabled, the scanner will verify the check character of the labels.

START / END	
PROGRAMMING bar codes	
	Disable Check Char Verification DEFAULT
Enable Check Char Verification	

Check Character Transmit

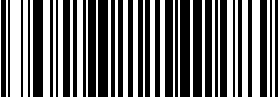
Enable this option to transmit the check character with scanned bar code data.



START / END	
PROGRAMMING bar codes	
	Disable Check Char Transmission
Enable Check Char Transmission DEFAULT	

Codabar — continued

Length Control

Fixed Length Decoding— When fixed length decoding is enabled, the scanner will decode a bar code if the label length matches one of the configurable fixed lengths.

Variable Length Decoding— When variable length decoding is enabled, the scanner will decode a bar code if the label length falls in the range of the configurable Length 1 and Length 2 values.

START / END	
PROGRAMMING bar codes	
	Variable Length Decoding DEFAULT
Fixed Length Decoding	

Codabar Length 1, Length 2 Programming Instructions

1. See [Length 1, Length 2 Programming Instructions on page 154](#) for detailed instructions on setting this feature.



NOTE





For Codabar bar codes, all start, stop, check and data characters are included in the length calculations.

START / END	
PROGRAMMING bar codes	
 DEFAULT SETTING FOR THIS FEATURE: 03	Set Length 1
Set Length 2	 DEFAULT SETTING FOR THIS FEATURE: 50

Codabar — continued

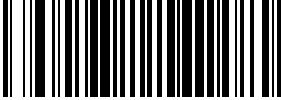
Start/Stop Character Type

Codabar has four pairs of Start/Stop patterns. Select one pair to match your application.

START / END		
PROGRAMMING bar codes		
	Start/Stop Type: ABCD/TN*E	
Start/Stop Type: ABCD/ABCD		
	Start/Stop Type: abcd/tn*e	
Start/Stop Type: abcd/abcd DEFAULT		



Start/Stop Character Transmission

The transmission of start and end characters of Codabar is selected below.

START / END		
PROGRAMMING bar codes		
	Disable Start/Stop Char Transmission	
Enable Start/Stop Char Transmission DEFAULT		

Start/Stop Character Match

This feature enables/disables the requirement that start and stop characters match.

START / END	
PROGRAMMING bar codes	
	Disable Start/Stop Char Match DEFAULT
Enable Start/Stop Char Match	

Code 93

The following options apply to the Code 93 symbology.

Disable/Enable Code 93

When this feature is disabled, the scanner will not read Code 93 bar codes.



START / END	
PROGRAMMING bar codes	
	Disable Code 93 DEFAULT
Enable Code 93	

Code 93 — continued

Length Control

Fixed Length Decoding— When fixed length decoding is enabled, the scanner will decode a bar code if the label length matches one of the configurable fixed lengths.

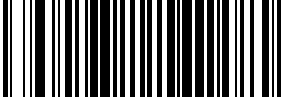
Variable Length Decoding— When variable length decoding is enabled, the scanner will decode a bar code if the label length falls in the range of the configurable Length 1 and Length 2 values.

START / END	
PROGRAMMING bar codes	
	Variable Length Decoding DEFAULT
Fixed Length Decoding	



Code 93 Length 1, Length 2 Programming Instructions

1. See [Length 1, Length 2 Programming Instructions on page 154](#) for detailed instructions on setting this feature.



For Code 93 bar codes, only the data characters are included in the length calculations.

NOTE



START / END	
PROGRAMMING bar codes	
 DEFAULT SETTING FOR THIS FEATURE: 01	Set Length 1
Set Length 2	 DEFAULT SETTING FOR THIS FEATURE: 50

MSI

The following options apply to the MSI symbology.

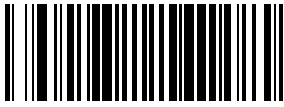

Disable/Enable MSI

When this feature is disabled, the scanner will not read MSI bar codes.

START / END	
PROGRAMMING bar codes	
	Disable Code 93 DEFAULT
Enable Code 93	

MSI Check Character Transmit

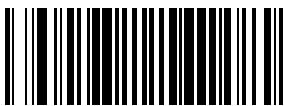
Enable this option to transmit the check character with scanned bar code data. Applies when [MSI Check Character Calculation](#) is enabled.

START / END	
PROGRAMMING bar codes	
	Disable Check Char Transmission
Enable Check Char Transmission DEFAULT	

MSI — continued

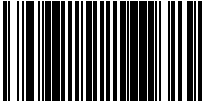
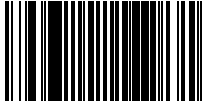

MSI Check Character Calculation

Enables/disables calculation and verification of optional MSI check characters. When disabled, any check characters in an MSI label are treated as data characters.

START / END	
PROGRAMMING bar codes	
	Disable Check Character Calculation
Enable Check Character Calculation DEFAULT	

MSI Number of Check Characters

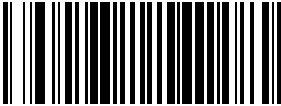
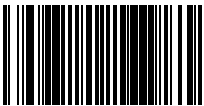
Specifies number of MSI check characters to be calculated and verified.

START / END	
PROGRAMMING bar codes	
	One Check Character DEFAULT
Two Check Characters	

MSI — continued

MSI Length Control

Specifies either variable-length decoding or fixed-length decoding for MSI.

Fixed Length Decoding— When fixed length decoding is enabled, the scanner will decode a bar code if the label length matches one of the configurable fixed lengths.

Variable Length Decoding— When variable length decoding is enabled, the scanner will decode a bar code if the label length falls in the range of the configurable Length 1 and Length 2 values.

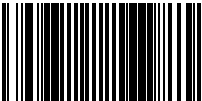
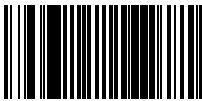
START / END	
PROGRAMMING bar codes	
	Variable Length Decoding DEFAULT
Fixed Length Decoding	



MSI Length 1, Length 2 Programming Instructions

1. See [Length 1, Length 2 Programming Instructions on page 154](#) for detailed instructions on setting this feature.

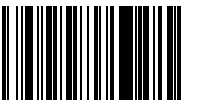

For MSI bar codes, length includes the bar-code's check and data characters.

NOTE

START / END	
PROGRAMMING bar codes	
 DEFAULT SETTING FOR THIS FEATURE: 04	Set Length 1
Set Length 2	 DEFAULT SETTING FOR THIS FEATURE: 10

NOTES

Chapter 7

2D Symbologies



The features in this section are available **ONLY** for models with 2D features activated.

NOTE

2D Symbologies

The scanner supports the 2D symbologies (bar code types) listed below. Available options for each 2D symbology are included in this chapter.



- PDF 417
- Micro PDF 417
- Datamatrix
- QR Code
- Maxicode
- Aztec
- Composite Labels

Factory Defaults— for the standard RS-232 interface are indicated in bold text throughout.

PDF 417

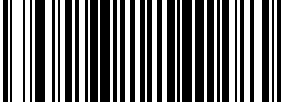

Disable/Enable PDF 417

When disabled, the scanner will not read PDF 417 bar codes.

START / END	
PROGRAMMING bar codes	
	Disable PDF 417
Enable PDF 417 DEFAULT	

Allow Zero Length PDF 417 Reading

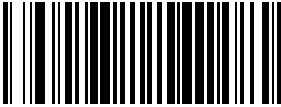
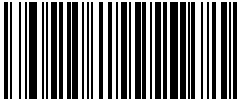
This enables/disables the scanner's ability to read PDF417 bar codes containing a zero length codeword.

START / END	
PROGRAMMING bar codes	
	Disable Zero Length PDF 417 Reading DEFAULT
Enable Zero Length PDF 417 Reading	

PDF 417 — cont.

Length Control

Fixed Length Decoding— When fixed length decoding is enabled, the scanner will decode a bar code if the label length matches one of the configurable fixed lengths.



Variable Length Decoding— When variable length decoding is enabled, the scanner will decode a bar code if the label length falls in the range of the configurable Length 1 and Length 2 values.

Configuring Fixed Length Decoding:

1. Scan the START bar code.
2. Scan the Fixed Length Decoding bar code.
3. Scan the END bar code.
4. Set Length 1 to the first fixed length by following the Length 1, Length 2 Programming Instructions below.
5. Set Length 2 to the second fixed length (or to '0000' if there is only one fixed length) by following the [PDF 417 Length 1, Length 2 Programming Instructions](#) below.

Configuring Variable Length Decoding:

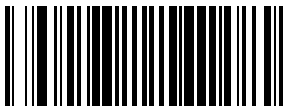
1. Scan the START bar code.
2. Scan the Variable Length Decoding bar code.
3. Scan the END bar code.
4. Set Length 1 to the minimum length by following the [PDF 417 Length 1, Length 2 Programming Instructions](#) below.
5. Set Length 2 to the maximum length by following the [PDF 417 Length 1, Length 2 Programming Instructions](#) below.

START / END	
PROGRAMMING bar codes	
	Variable Length Decoding DEFAULT
Fixed Length Decoding	

PDF 417 – cont.

PDF 417 Length 1, Length 2 Programming Instructions

1. Scan the START bar code.
2. Scan either the Set Length 1 or Set Length 2 bar code.
3. Turn to [Appendix C, Alpha-Numeric Pad](#) and scan the four digits (zero-padded) representing the length.





For PDF 417 bar codes, only the data characters are included in the length calculations.

NOTE

Any value set higher than 2710 will be considered to be 2710.

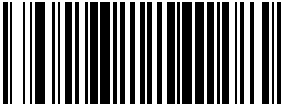
Scan the END bar code.

START / END	
PROGRAMMING bar codes	
 DEFAULT SETTING FOR THIS FEATURE: 0001	Set Length 1
Set Length 2	 DEFAULT SETTING FOR THIS FEATURE: 2710

Micro PDF 417

Disable/Enable Micro PDF 417

When disabled, the scanner will not read Micro PDF 417 bar codes.

START / END	
PROGRAMMING bar codes	
	Disable Micro PDF 417 DEFAULT
Enable Micro PDF 417	

Micro PDF 417 – cont.

Length Control

Fixed Length Decoding— When fixed length decoding is enabled, the scanner will decode a bar code if the label length matches one of the configurable fixed lengths.



Variable Length Decoding— When variable length decoding is enabled, the scanner will decode a bar code if the label length falls in the range of the configurable Length 1 and Length 2 values.

Configuring Fixed Length Decoding:

1. Scan the START bar code.
2. Scan the Fixed Length Decoding bar code.
3. Scan the END bar code.
4. Set Length 1 to the first fixed length by following the Length 1, Length 2 Programming Instructions below.
5. Set Length 2 to the second fixed length (or to '0000' if there is only one fixed length) by following the [Micro PDF 417 Length 1, Length 2 Programming Instructions](#) below.

Configuring Variable Length Decoding:

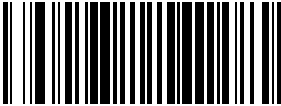
1. Scan the START bar code.
2. Scan the Variable Length Decoding bar code.
3. Scan the END bar code.
4. Set Length 1 to the minimum length by following the [Micro PDF 417 Length 1, Length 2 Programming Instructions](#) below.
5. Set Length 2 to the maximum length by following the [Micro PDF 417 Length 1, Length 2 Programming Instructions](#) below.

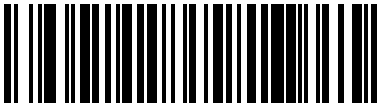
START / END	
PROGRAMMING bar codes	
	Variable Length Decoding DEFAULT
Fixed Length Decoding	

Micro PDF 417 — cont.

Micro PDF 417 Length 1, Length 2 Programming Instructions

1. Scan the START bar code.
2. Scan either the Set Length 1 or Set Length 2 bar code.
3. Turn to [Appendix C, Alpha-Numeric Pad](#) and scan the four digits (zero-padded) representing the length.



For Micro PDF 417 bar codes, only the data characters are included in the length calculations.

NOTE

Any value set higher than 366 will be considered to be 366.

Scan the END bar code.

START / END	
PROGRAMMING bar codes	
 DEFAULT SETTING FOR THIS FEATURE: 0001	Set Length 1
Set Length 2	 DEFAULT SETTING FOR THIS FEATURE: 0366

Datamatrix

Disable/Enable Datamatrix

When disabled, the scanner will not read Datamatrix bar codes.

START / END	
PROGRAMMING bar codes	
	Disable Datamatrix
Enable Datamatrix DEFAULT	

Datamatrix — cont.

Length Control

Fixed Length Decoding— When fixed length decoding is enabled, the scanner will decode a bar code if the label length matches one of the configurable fixed lengths.



Variable Length Decoding— When variable length decoding is enabled, the scanner will decode a bar code if the label length falls in the range of the configurable Length 1 and Length 2 values.

Configuring Fixed Length Decoding:

1. Scan the START bar code.
2. Scan the Fixed Length Decoding bar code.
3. Scan the END bar code.
4. Set Length 1 to the first fixed length by following the Length 1, Length 2 Programming Instructions below.
5. Set Length 2 to the second fixed length (or to '0000' if there is only one fixed length) by following the [Datamatrix Length 1, Length 2 Programming Instructions](#) below.

Configuring Variable Length Decoding:

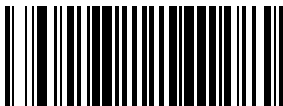
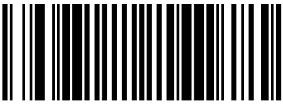
1. Scan the START bar code.
2. Scan the Variable Length Decoding bar code.
3. Scan the END bar code.
4. Set Length 1 to the minimum length by following the [Datamatrix Length 1, Length 2 Programming Instructions](#) below.
5. Set Length 2 to the maximum length by following the [Datamatrix Length 1, Length 2 Programming Instructions](#) below.

START / END	
PROGRAMMING bar codes	
	Variable Length Decoding DEFAULT
Fixed Length Decoding	

Datamatrix – cont.

Datamatrix Length 1, Length 2 Programming Instructions

1. Scan the START bar code.
2. Scan either the Set Length 1 or Set Length 2 bar code.
3. Turn to [Appendix C, Alpha-Numeric Pad](#) and scan the four digits (zero-padded) representing the length.





For Datamatrix bar codes, only the data characters are included in the length calculations.

NOTE

Any value set higher than 800 will be considered to be 800.

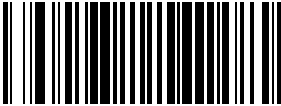
Scan the END bar code.

START / END	
PROGRAMMING bar codes	
 DEFAULT SETTING FOR THIS FEATURE: 0001	Set Length 1
Set Length 2	 DEFAULT SETTING FOR THIS FEATURE: 0800

QR Code

Disable/Enable QR Code

When disabled, the scanner will not read QR Code labels.

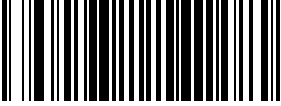
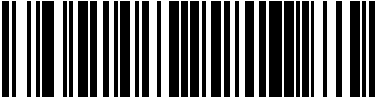
START / END	
PROGRAMMING bar codes	
	Disable QR Code DEFAULT
Enable QR Code	

QR Code – cont.

Length Control

Fixed Length Decoding— When fixed length decoding is enabled, the scanner will decode a bar code if the label length matches one of the configurable fixed lengths.



Variable Length Decoding— When variable length decoding is enabled, the scanner will decode a bar code if the label length falls in the range of the configurable Length 1 and Length 2 values.

Configuring Fixed Length Decoding:

1. Scan the START bar code.
2. Scan the Fixed Length Decoding bar code.
3. Scan the END bar code.
4. Set Length 1 to the first fixed length by following the Length 1, Length 2 Programming Instructions below.
5. Set Length 2 to the second fixed length (or to '0000' if there is only one fixed length) by following the [QR Code Length 1, Length 2 Programming Instructions](#) below.

Configuring Variable Length Decoding:

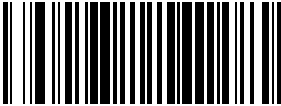
1. Scan the START bar code.
2. Scan the Variable Length Decoding bar code.
3. Scan the END bar code.
4. Set Length 1 to the minimum length by following the [QR Code Length 1, Length 2 Programming Instructions](#) below.
5. Set Length 2 to the maximum length by following the [QR Code Length 1, Length 2 Programming Instructions](#) below.

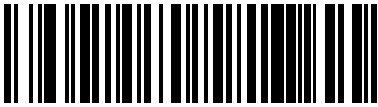
START / END	
PROGRAMMING bar codes	
	Variable Length Decoding DEFAULT
Fixed Length Decoding	

QR Code – cont.

QR Code Length 1, Length 2 Programming Instructions

1. Scan the START bar code.
2. Scan either the Set Length 1 or Set Length 2 bar code.
3. Turn to [Appendix C, Alpha-Numeric Pad](#) and scan the four digits (zero-padded) representing the length.



For 2d Code labels, only the data characters are included in the length calculations.

NOTE

Any value set higher than 2710 will be considered to be 2710.

Scan the END bar code.



Maxicode

Disable/Enable Maxicode

When disabled, the scanner will not read Maxicode labels.

START / END	
PROGRAMMING bar codes	
	Disable Maxicode DEFAULT
Enable Maxicode	

Maxicode — cont.

Length Control

Fixed Length Decoding— When fixed length decoding is enabled, the scanner will decode a bar code if the label length matches one of the configurable fixed lengths.

Variable Length Decoding— When variable length decoding is enabled, the scanner will decode a bar code if the label length falls in the range of the configurable Length 1 and Length 2 values.

Configuring Fixed Length Decoding:

1. Scan the START bar code.
2. Scan the Fixed Length Decoding bar code.
3. Scan the END bar code.
4. Set Length 1 to the first fixed length by following the Length 1, Length 2 Programming Instructions below.
5. Set Length 2 to the second fixed length (or to '0000' if there is only one fixed length) by following the [Maxicode Length 1, Length 2 Programming Instructions](#) below.

Configuring Variable Length Decoding:

1. Scan the START bar code.
2. Scan the Variable Length Decoding bar code.
3. Scan the END bar code.
4. Set Length 1 to the minimum length by following the [Maxicode Length 1, Length 2 Programming Instructions](#) below.
5. Set Length 2 to the maximum length by following the [Maxicode Length 1, Length 2 Programming Instructions](#) below.

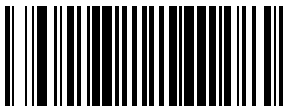
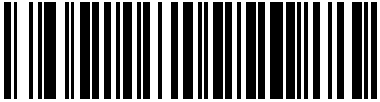
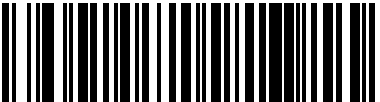
START / END	
PROGRAMMING bar codes	
	Variable Length Decoding DEFAULT
Fixed Length Decoding	

Maxicode – cont.

Maxicode Length 1, Length 2 Programming Instructions

1. Scan the START bar code.
2. Scan either the Set Length 1 or Set Length 2 bar code.
3. Turn to [Appendix C, Alpha-Numeric Pad](#) and scan the four digits (zero-padded) representing the length.





For Maxicode labels, only the data characters are included in the length calculations.

NOTE

Any value set higher than 138 will be considered to be 138.

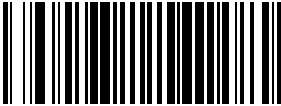
Scan the END bar code.

START / END	
PROGRAMMING bar codes	
 DEFAULT SETTING FOR THIS FEATURE: 0001	Set Length 1
Set Length 2	 DEFAULT SETTING FOR THIS FEATURE: 0138

Aztec

Disable/Enable Aztec

When disabled, the scanner will not read Aztec labels.

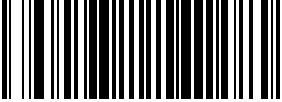
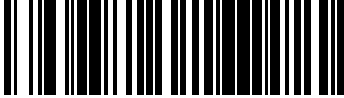
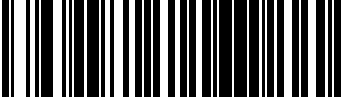
START / END	
PROGRAMMING bar codes	
	Disable Aztec DEFAULT
Enable Aztec	

Aztec – cont.

Length Control

Fixed Length Decoding— When fixed length decoding is enabled, the scanner will decode a bar code if the label length matches one of the configurable fixed lengths.

Variable Length Decoding— When variable length decoding is enabled, the scanner will decode a bar code if the label length falls in the range of the configurable Length 1 and Length 2 values.

Configuring Fixed Length Decoding:

1. Scan the START bar code.
2. Scan the Fixed Length Decoding bar code.
3. Scan the END bar code.
4. Set Length 1 to the first fixed length by following the Length 1, Length 2 Programming Instructions below.
5. Set Length 2 to the second fixed length (or to '0000' if there is only one fixed length) by following the [Aztec Length 1, Length 2 Programming Instructions](#) below.

Configuring Variable Length Decoding:

1. Scan the START bar code.
2. Scan the Variable Length Decoding bar code.
3. Scan the END bar code.
4. Set Length 1 to the minimum length by following the [Aztec Length 1, Length 2 Programming Instructions](#) below.
5. Set Length 2 to the maximum length by following the [Aztec Length 1, Length 2 Programming Instructions](#) below.

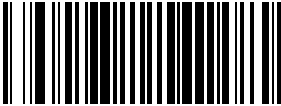
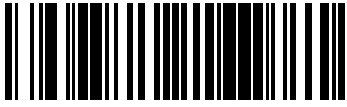
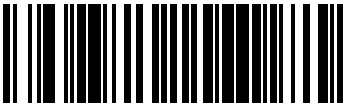
START / END	
PROGRAMMING bar codes	
	Variable Length Decoding DEFAULT
Fixed Length Decoding	

Aztec – cont.

Aztec Length 1, Length 2 Programming Instructions

1. Scan the START bar code.
2. Scan either the Set Length 1 or Set Length 2 bar code.
3. Turn to [Appendix C, Alpha-Numeric Pad](#) and scan the four digits (zero-padded) representing the length.



For Aztec labels, only the data characters are included in the length calculations.

NOTE

Any value set higher than 3700 will be considered to be 2710.

Scan the END bar code.

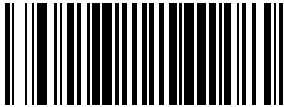
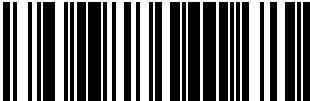

START / END	
PROGRAMMING bar codes	
 DEFAULT SETTING FOR THIS FEATURE: 0001	Set Length 1
Set Length 2	 DEFAULT SETTING FOR THIS FEATURE: 2710

Composite Labels

Disable/Enable GS1 DataBar Omnidirectional 2D Component

When enabled, if a GS1 DataBar Omnidirectional label is decoded which has the 2D linkage flag set, the 2D component must also be decoded or the base label will be discarded.

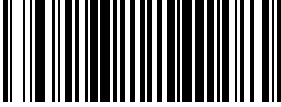
When disabled, only the GS1 DataBar Omnidirectional base label will be decoded and transmitted regardless of the state of the linkage flag.

START / END	
PROGRAMMING bar codes	
	Disable GS1 DataBar Omnidirectional 2D Component DEFAULT
Enable GS1 DataBar Omnidirectional 2D Component	

Disable/Enable GS1 DataBar Expanded 2D Component

When enabled, if a GS1 DataBar Expanded label is decoded which has the 2D linkage flag set, the 2D component must also be decoded or the base label will be discarded.

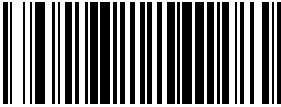
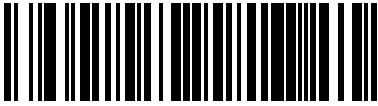

When disabled, only the GS1 DataBar Expanded base label will be decoded and transmitted regardless of the state of the linkage flag.

START / END	
PROGRAMMING bar codes	
	Disable GS1 DataBar Expanded 2D Component DEFAULT
Enable GS1 DataBar Expanded 2D Component	

Disable/Enable GS1 DataBar Limited 2D Component

When enabled, if a GS1 DataBar Limited label is decoded which has the 2D linkage flag set, the 2D component must also be decoded or the base label will be discarded.

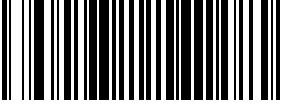
When disabled, only the GS1 DataBar Limited base label will be decoded and transmitted regardless of the state of the linkage flag.

START / END	
PROGRAMMING bar codes	
	Disable GS1 DataBar Limited 2D Component DEFAULT
Enable GS1 DataBar Limited 2D Component	

NOTES

Chapter 8

Advanced Decoding Features





Inverse Label Reading

This controls the method of reading inverse labels (white label on black background).



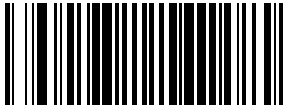

This feature is only available for GS1 DataBar and 2D symbologies.

NOTE

START / END	
PROGRAMMING bar codes	
	2D Read Mode = Reads only normal labels DEFAULT
2D Read Mode = Reads both normal and inverse labels	
	2D Read Mode = Reads only inverse labels

UPC/EAN Quiet Zone

This feature sets a Quiet Zone requirement for UPC/EAN labels.

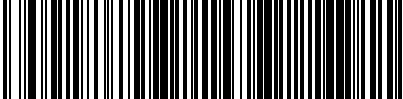
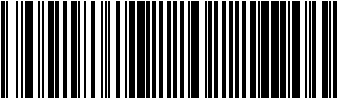
START / END	
PROGRAMMING bar codes	
	UPC/EAN Quiet Zone = 5 Modules
UPC/EAN Quiet Zone = 3 Modules	
	UPC/EAN Quiet Zone = 1.5 Modules

Chapter 9

References

This section contains explanations and examples of selected bar code features. See the programming sections for the actual bar code labels used to configure the reader.

Global Prefix/Suffix

Up to 20 ASCII characters may be added as a prefix (in a position before the bar code data) and/or as a suffix (in a position following the bar code data) as indicated in Figure 6.

Figure 6. Prefix and Suffix Positions

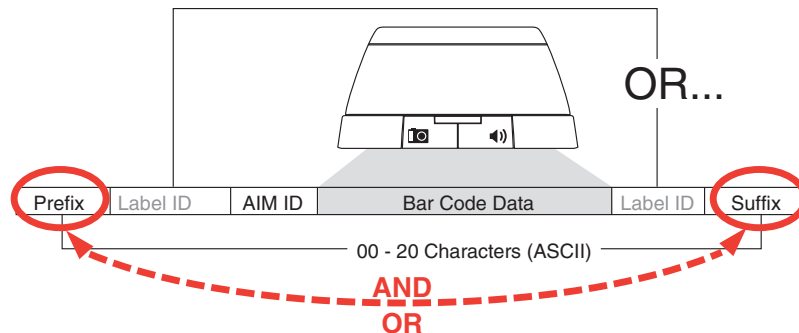

Example: Setting a Prefix

In this example, we'll set a prefix for all symbologies.

1. Determine which ASCII character(s) are to be added to scanned bar code data. In this example, we'll add a dollar sign ('\$') as a prefix.
2. Scan the START bar code.
3. Scan the SET PREFIX bar code.
4. Reference the [ASCII Chart](#) on the inside back cover of this manual, to find the hex value assigned to the desired character. The corresponding hex number for the '\$' character is 24. To enter this selection code, scan the '2' and '4' bar codes from [Appendix C, Alpha-Numeric Pad](#).
5. Scan the END bar code once to finish the string, then scan END again to exit Programming Mode.



If all 20 characters will be used in the prefix or suffix, do not scan the END bar code to finish the string. It is done automatically.

NOTE

6. The resulting message string would appear as follows:

Scanned bar code data:12345

Resulting message string output: \$12345

Label ID

A Label ID is used to identify a bar code (symbology) type. See [Appendix D, Factory Default Settings](#), for a listing for common symbologies. It can be appended previous to or following the transmitted bar code data depending upon how this option is enabled. This feature provides options for configuring custom Label IDs individually per symbology. If you wish to program the scanner to always include an industry standard label identifier for ALL symbology types, see the feature, [AIM ID on page 75](#).

The Label ID is a customizable code of up to three ASCII characters (each of which are 00-7F) followed by a control character (00-01). This control character, when set to zero, does nothing. When set to one, it appends the symbology's AIM ID to the Label ID.



When the control character is set to 01 for UPC-A and UPC-E, it expands the label to EAN-13 and thus follows the EAN-13 Label ID settings.

NOTE

To configure a Label ID:

1. Scan the START bar code.
2. Select Label ID position as either BEFORE or AFTER by scanning the appropriate bar code.
3. Scan a bar code to select the symbology for which you wish to configure a custom Label ID.
4. Determine the desired character(s) (you may choose up to three) which will represent the Label ID for the selected symbology. Next, turn to the [ASCII Chart](#) on the inside back cover of this manual and find the equivalent hex digits associated with your choice of Label ID. For example, if you wish to select an equal sign (=) as a Label ID, the chart indicates its associated hex characters as 3D.
5. Turn to [Appendix C, Alpha-Numeric Pad](#) and scan the bar codes representing the hex characters determined in the previous step. For example, to make an equal sign (=), scan '3' and 'D' followed by '0' six times. Since this is a three-character buffer, '00' is scanned for character two, '00' for character three and '00' for the control character. ('00' indicates no character.)
6. Scan the END bar code to exit programming mode.

Figure 7. Label ID Position Options

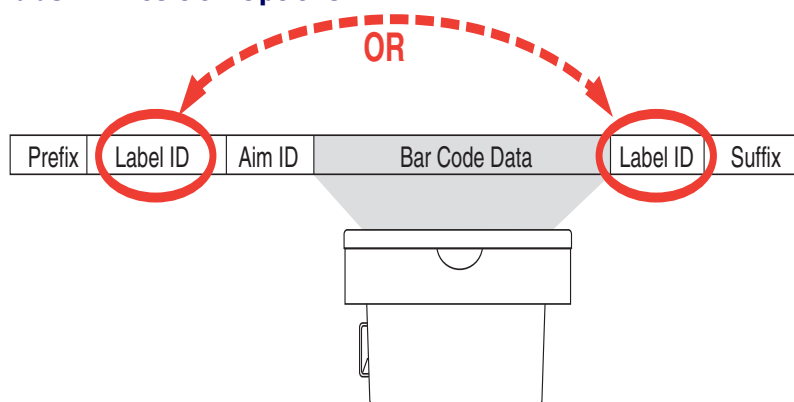

Length Control

Fixed Length Decoding— When fixed length decoding is enabled, the scanner will decode a bar code if the label length matches one of the configurable fixed lengths.

Variable Length Decoding— When variable length decoding is enabled, the scanner will decode a bar code if the label length falls in the range of the configurable minimum and maximum length.

Configuring Fixed Length Decoding:

1. Scan the START/END bar code.
2. Scan the Fixed Length Decoding bar code for the desired symbology.
3. Scan the START/END bar code.
4. Set Length 1 to the first fixed length by following the [Length 1, Length 2 Programming Instructions](#) below.
5. Set Length 2 to the second fixed length (or to '00' if there is only one fixed length) by following the [Length 1, Length 2 Programming Instructions](#) below.

Configuring Variable Length Decoding:

1. Scan the START/END bar code.
2. Scan the Variable Length Decoding bar code for the desired symbology.
3. Scan the START/END bar code.
4. Set Length 1 to the first variable length by following the [Length 1, Length 2 Programming Instructions](#) below.
5. Set Length 2 to the second variable length by following the [Length 1, Length 2 Programming Instructions](#) below.

Length 1, Length 2 Programming Instructions

1. Scan the START/END bar code.
2. Scan either the Set Length 1 or Set Length 2 bar code for the desired symbology.
3. Turn to [Appendix C, Alpha-Numeric Pad](#) and scan the two digits (zero padded) representing the length in decimal notation. The number of characters that can be set varies, depending upon the symbology. Reference the page for your selected symbology to see specific variables.
4. Scan the START/END bar code

Appendix A

Product Specifications

Optical and Read Performance Parameters

Parameter	Specification
Scan Volume	250 cubic inches
Minimum Resolution	5 mil
Depth of Field (100% UPC Labels)	0 - 8" (0 - 20.32cm)
Minimum Print Contrast Ratio	25%
Skew (Yaw)	$\pm 75^\circ$
Pitch	$\pm 65^\circ$
Roll	Between 0 and 360°

Scanner Dimensions

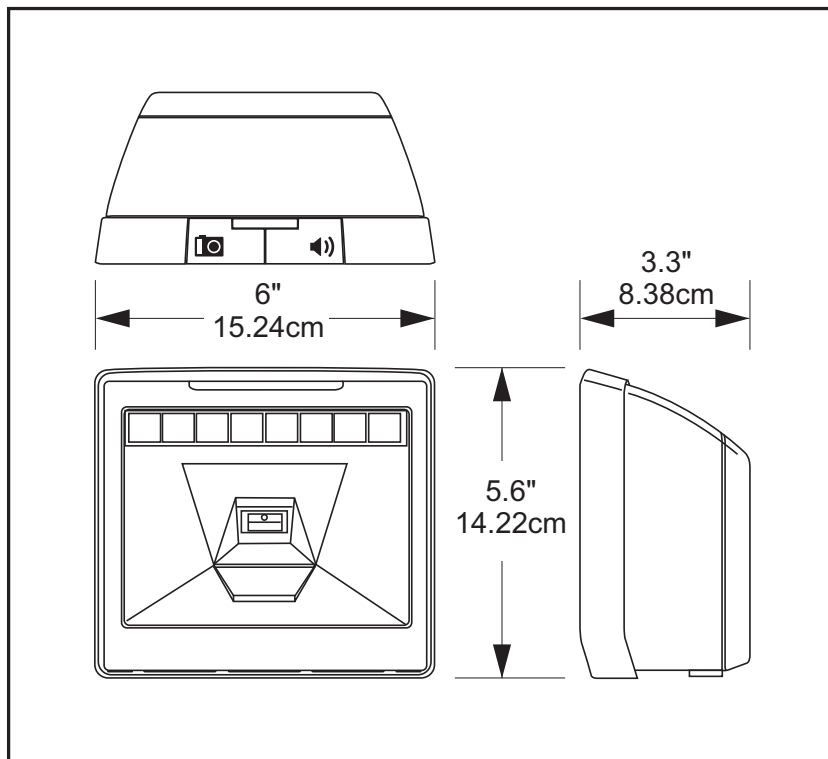

Physical Properties

Parameter	Specification
Dimensions (Scanner only):	6" x 5.6" x 3.3" (WxHxD)
Weight (Scanner)	1 lb 4.6 oz (0.584kg)

Electrical Parameters

Parameters	Specification	
AC Power Requirements	AC Input: 90-264 VAC, 47~63Hz	
AC Power Consumption	Real Power	
Operating (Maximum)	8.75Watts	
Operating (Nominal)	2.8Watts	
Sleep mode	2.0Watts	
DC Power Requirements	Reference for POT user	
Input Voltage	7 to 14 V DC	
Operating Current and Power at 12V DC	Current	Power
Maximum Inrush	715mA	8.6 Watts
Maximum Continuous	545mA	6.6 Watts
Nominal Scanner Only	180mA	2.2 Watts
Sleep, Scanner Only	123mA	1.5 Watts

Environmental Parameters

Parameter	Specification
Contaminants Water and Dust	IP5x
Temperature Ranges: Operating	32° F to +104° F (0° C to +40° C)
Storage	-40° F to +158° F (-40° C to +70° C)
Ambient Light Indoor	0 - 6,000 lux
Ambient Light Outdoor	0 - 86,100 lux
Humidity	5% to 95% non-condensing
Beeper/Speaker	70-90dBA at a distance of 3'-3" (1 meter)
Vibration	Retail/Office

Other Parameters

Parameter	Specification
EAS Support	YES (Checkpoint)

Appendix B

Cable Pinouts

Standard Cable Pinouts (Primary Interface Cables)

Pin #	RS-232	IBM Port 5B/9B/17	USB-OEM	USB, USB Keyboard, USB COM	Keyboard Wedge
1	DTR				PCCLK
2	CTS				
3			VBUS	VBUS	
4	RTS	Line B	D-	D-	KBCLK
5	RxD				
6	TxD	Line A	D+	D+	PC Data
7					
8	VCC in	VCC in	+12V	VCC in	VCC in
9	GND	GND	GND	GND	GND
10					KBD

Cable Pinouts (Handheld Scanner Attached via the Aux Port)

PIN #	HANDHELD ATTACHED TO AUX PORT
1	
2	AUX_CTS
3	
4	AUX_RTS
5	AUX_RxD
6	AUX_TxD
7	AUX_ERI
8	VCC
9	GND
10	

NOTES

Appendix C

Alpha-Numeric Pad



A



B



C



D



E



F

Alpha-Numeric Pad



1



NOTE

Note for numeric entry sequences, the scanner will announce the number of digits remaining to be entered after each label read.



2



3



4

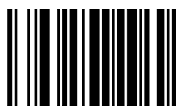

5

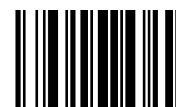

6



7



8



9



0

Appendix D

Factory Default Settings

Factory Defaults by Interface

The following is a partial list of key settings for each interface type.

FEATURE	Aux	RS-232	Wincor-Nixdorf	Single Cable	USB-OEM	Keybd Wedge
Double Read Timeout for Linear Labels	40 (400ms)	40 (400ms)	40 (400ms)	40 (400ms)	40 (400ms)	40 (400ms)
Double Read Timeout for 2D Labels	700ms	700ms	700ms	700ms	700ms	700ms
Scanner Button Options	Enable only vol, tone, and reset	Enable only vol, tone, and reset	Enable only vol, tone, and reset	Enable only vol, tone, and reset	Enable only vol, tone, and reset	Enable only vol, tone, and reset
Camera Button Mode	Normal Take Pix	Normal Take Pix	Normal Take Pix	Normal Take Pix	Normal Take Pix	Normal Take Pix
LED Level	Default Level	Default Level	Default Level	Default Level	Default Level	Default Level
Auxiliary Port Mode	Disable	Disable	Disable	Disable	Disable	Disable
Auxiliary Port Baud Rate	19200	19200	19200	19200	19200	19200
Productivity Index Reporting (PIR)	Disable	Disable	Disable	Disable	Disable	Disable
Sleep Mode	5 Minutes	5 Minutes	5 Minutes	5 Minutes	5 Minutes	5 Minutes
LED and Beeper Indicators	Enable	Enable	Enable	Enable	Enable	Enable
Image Compression	100 (minimum)	100 (minimum)	100 (minimum)	100 (minimum)	100 (minimum)	100 (minimum)
Image Format	JPG	JPG	JPG	JPG	JPG	JPG
Image Size	VGA	VGA	VGA	VGA	VGA	VGA
Image Brightness	09	09	09	09	09	09
Image Contrast	09	09	09	09	09	09
	Disable	Disable	Disable	Disable	Disable	Disable
Obey/Ignore Host Commands	Obey	Obey	Obey	Obey	Obey	Obey

FEATURE	Aux	RS-232	Wincor-Nixdorf	Single Cable	USB-OEM	Keybd Wedge
Host Transmission Buffers	2	2	2	2	2	2
Baud Rate	9600	9600	9600	9600	9600	9600
Data Bits	8	8	8	8	8	8
Stop Bits	1	1	1	1	1	1
Parity	None	None	None	None	None	None
Hardware Flow Control	Disable	Disable	Disable	Disable	Disable	Disable
Intercharacter Delay	No Delay	No Delay	No Delay	No Delay	No Delay	No Delay
Software Flow Control	Disable	Disable	Disable	Disable	Disable	Disable
Host Echo	Disable	Disable	Disable	Disable	Disable	Disable
Host Echo Quiet Interval	10 msec	10 msec	10 msec	10 msec	10 msec	10 msec
Signal Voltage: Normal/TTL	Normal RS-232	Normal RS-232	Normal RS-232	Normal RS-232	Normal RS-232	Normal RS-232
RS-232 Invert	Disable	Disable	Disable	Disable	Disable	Disable
Beep on ASCII BEL	Enable	Enable	Enable	Enable	Enable	Enable
Beep on Not on File	Enable	Enable	Enable	Enable	Enable	Enable
ACK NAK Options	Disable	Disable	Disable	Disable	Disable	Disable
ACK Character	006	006	006	006	006	006
NAK Character	021	021	021	021	021	021
Retry on ACK NAK Timeout	Enable	Enable	Enable	Enable	Enable	Enable
ACK NAK Timeout Value	001	001	001	001	001	001
ACK NAK Retry Count	003	003	003	003	003	003
ACK NAK Error Handling	Ignore	Ignore	Ignore	Ignore	Ignore	Ignore
Transmission Failure Indication	Enable	Enable	Enable	Enable	Enable	Enable
Single Cable RS-232 Options				RTS held high, wait for CTS to be asserted		
Single Cable RS-232 Use BCC				Enable		
Single Cable RS-232 Use ACK/NAK				Enable		
Single Cable RS-232 Use STX				Enable		
Set Single Cable RS-232 STX Character				53		
Single Cable RS-232 Use ETX				Enable		

FEATURE	Aux	RS-232	Wincor-Nixdorf	Single Cable	USB-OEM	Keybd Wedge
Set Single Cable RS-232 ETX Character				0D		
Single Cable Pacesetter Plus				Disable		
Single Cable Datalogic Extensions				Disable		
USB-OEM Interface Features					Config as table top scanner	
IBM Transmit Labels in Code 39 Format					Disable	
Keyboard Layout						USA
Caps Lock State						Disable
Power-On Simulation						Disable
Control Characters						Disable
Wedge Quiet Interval						010
Intercharacter Delay						No Delay
Global Prefix/Suffix	Prefix 00 Suffix 0D	Prefix 00 Suffix 0D	Prefix 00 Suffix 0D	Prefix 00 Suffix 0D	Prefix 00 Suffix 0D	Prefix 00 Suffix 0D
AIM ID	Disable	Disable	Disable	Disable	Disable	Disable
Label ID Position	Before barcode data	Before barcode data	Before barcode data	Before barcode data	Before barcode data	Before barcode data
Case Conversion	Disable	Disable	Disable	Disable	Disable	Disable
Character Conversion	No Con- version	No Con- version	No Con- version	No Con- version	No Con- version	No Con- version
Disable/Enable UPC-A	Enable	Enable	Enable	Enable	Enable	Enable
Check Digit Transmission	Send	Send	Send	Send	Send	Send
Number System Transmission	Enable	Enable	Enable	Enable	Enable	Enable
Expand UPC-A to EAN-13	Don't Expand	Don't Expand	Don't Expand	Don't Expand	Don't Expand	Don't Expand
Disable/Enable UPC-E	Enable	Enable	Enable	Enable	Enable	Enable
Check Digit Transmission	Send	Send	Send	Send	Send	Send
Number System Digit	Exclude	Exclude	Exclude	Exclude	Exclude	Exclude
Expand to UPC-E to UPC-A	Don't Expand	Don't Expand	Don't Expand	Don't Expand	Don't Expand	Don't Expand
Expand UPC-E to EAN13	Don't Expand	Don't Expand	Don't Expand	Don't Expand	Don't Expand	Don't Expand

FEATURE	Aux	RS-232	Wincor-Nixdorf	Single Cable	USB-OEM	Keybd Wedge
Expand UPC/EAN to GTIN	Don't Expand	Don't Expand	Don't Expand	Don't Expand	Don't Expand	Don't Expand
Disable/Enable EAN-13	Enable	Enable	Enable	Enable	Enable	Enable
Check Digit Transmission	Send	Send	Send	Send	Send	Send
EAN-13 Flag 1 Character	Transmit	Transmit	Transmit	Transmit	Transmit	Transmit
ISBN	Disable	Disable	Disable	Disable	Disable	Disable
Disable/Enable EAN-8	Enable	Enable	Enable	Enable	Enable	Enable
Check Digit Transmission	Send	Send	Send	Send	Send	Send
Expand EAN-8 to EAN-13	Don't Expand	Don't Expand	Don't Expand	Don't Expand	Don't Expand	Don't Expand
EAN Two-Label	Disable	Disable	Disable	Disable	Disable	Disable
EAN Two-Label Combined Transmission	Disable	Disable	Disable	Disable	Disable	Disable
Price Weight Check Digit	Disable	Disable	Disable	Disable	Disable	Disable
Add-ons	Disable	Disable	Disable	Disable	Disable	Disable
Disable/Enable GS1 DataBar Omnidirectional	Disable	Disable	Disable	Disable	Disable	Disable
UCC/EAN 128 Emulation	Disable	Disable	Disable	Disable	Disable	Disable
Disable/Enable GS1 DataBar Expanded	Disable	Disable	Disable	Disable	Disable	Disable
GS1-128 Emulation	Disable	Disable	Disable	Disable	Disable	Disable
Length Control	Variable 01/74	Variable 01/74	Variable 01/74	Variable 01/74	Variable 01/74	Variable 01/74
Coupon Read Control	Enable UPCA Disable GS1 Data-Bar	Enable UPCA Disable GS1 Data-Bar	Enable UPCA Disable GS1 Data-Bar	Enable UPCA Disable GS1 Data-Bar	Enable UPCA Disable GS1 Data-Bar	Enable UPCA Disable GS1 Data-Bar
Disable/Enable GS1 DataBar Limited	Disable	Disable	Disable	Disable	Disable	Disable
GS1-128 Emulation	Disable	Disable	Disable	Disable	Disable	Disable
Disable/Enable Code 39	Enable	Enable	Disable	Enable	Enable	Enable
Check Character Calculation	Disable	Disable	Disable	Disable	Disable	Disable
Check Character Transmit	Enable	Enable	Enable	Enable	Enable	Enable
Start/Stop Characters	Don't Transmit	Don't Transmit	Don't Transmit	Don't Transmit	Don't Transmit	Don't Transmit
Code 39 Full ASCII	Disable	Disable	Disable	Disable	Disable	Disable

FEATURE	Aux	RS-232	Wincor-Nixdorf	Single Cable	USB-OEM	Keybd Wedge
Length Control	Variable 02/50	Variable 02/50	Variable 02/50	Variable 02/50	Variable 02/50	Variable 02/50
Disable/Enable Code 32 Italian Pharmaco- code	Disable	Disable	Disable	Disable	Disable	Disable
Start/Stop Characters	Don't Transmit	Don't Transmit	Don't Transmit	Don't Transmit	Don't Transmit	Don't Transmit
Check Character Transmit	Enable	Enable	Enable	Enable	Enable	Enable
Disable/Enable Code 128	Enable	Enable	Disable	Enable	Enable	Enable
Disable/Enable EAN 128	Disable	Disable	Disable	Disable	Disable	Disable
Transmit Function Characters	Don't Transmit	Don't Transmit	Don't Transmit	Don't Transmit	Don't Transmit	Don't Transmit
Length Control	Variable 01/80	Variable 01/80	Variable 01/80	Variable 01/80	Variable 01/80	Variable 01/80
Code 128 Conversion to Code 39	Disable	Disable	Disable	Disable	Disable	Disable
Disable/Enable Interleaved 2 of 5	Disable	Disable	Disable	Disable	Disable	Disable
Check Digit Calculation	Disable	Disable	Disable	Disable	Disable	Disable
Check Digit Transmit	Disable	Disable	Disable	Disable	Disable	Disable
Length Control	Variable 06/50	Variable 06/50	Variable 06/50	Variable 06/50	Variable 06/50	Variable 06/50
Disable/Enable Codabar	Disable	Disable	Disable	Disable	Disable	Disable
Check Character Verification	Disable	Disable	Disable	Disable	Disable	Disable
Check Character Transmit	Disable	Disable	Disable	Disable	Disable	Disable
Length Control	Variable 03/50	Variable 03/50	Variable 03/50	Variable 03/50	Variable 03/50	Variable 03/50
Start/Stop Character Type	abcd/abcd	abcd/abcd	abcd/abcd	abcd/abcd	abcd/abcd	abcd/abcd
Start/Stop Character Transmission	Enable	Enable	Enable	Enable	Enable	Enable
Start/Stop Character Match	Disable	Disable	Disable	Disable	Disable	Disable
Disable/Enable Code 93	Disable	Disable	Disable	Disable	Disable	Disable
Length Control	Variable 01/50	Variable 01/50	Variable 01/50	Variable 01/50	Variable 01/50	Variable 01/50
MSI Check Character Transmit	Enable	Enable	Enable	Enable	Enable	Enable
MSI Check Character Calculation	Enable	Enable	Enable	Enable	Enable	Enable
MSI Number of Check Characters	One	One	One	One	One	One
MSI Length Control	Variable 04/10	Variable 04/10	Variable 04/10	Variable 04/10	Variable 04/10	Variable 04/10

FEATURE	Aux	RS-232	Wincor-Nixdorf	Single Cable	USB-OEM	Keybd Wedge
Disable/Enable PDF 417	Enable	Enable	Enable	Enable	Enable	Enable
Length Control	Variable 0001/2710	Variable 0001/2710	Variable 0001/2710	Variable 0001/2710	Variable 0001/2710	Variable 0001/2710
Disable/Enable Micro PDF 417	Disable	Disable	Disable	Disable	Disable	Disable
Length Control	Variable 0001/0366	Variable 0001/0366	Variable 0001/0366	Variable 0001/0366	Variable 0001/0366	Variable 0001/0366
Disable/Enable Datamatrix	Disable	Disable	Disable	Disable	Disable	Disable
Length Control	Variable 0001/0800	Variable 0001/0800	Variable 0001/0800	Variable 0001/0800	Variable 0001/0800	Variable 0001/0800
Disable/Enable QR Code	Enable	Enable	Enable	Enable	Enable	Enable
Length Control	Variable 0001/2710	Variable 0001/2710	Variable 0001/2710	Variable 0001/2710	Variable 0001/2710	Variable 0001/2710
Disable/Enable Maxicode	Disable	Disable	Disable	Disable	Disable	Disable
Length Control	Variable 0001/0138	Variable 0001/0138	Variable 0001/0138	Variable 0001/0138	Variable 0001/0138	Variable 0001/0138
Disable/Enable Aztec	Disable	Disable	Disable	Disable	Disable	Disable
Length Control	Variable 0001/2710	Variable 0001/2710	Variable 0001/2710	Variable 0001/2710	Variable 0001/2710	Variable 0001/2710
Disable/Enable GS1 DataBar Omnidirectional 2D Component	Disable	Disable	Disable	Disable	Disable	Disable
Disable/Enable GS1 DataBar Expanded 2D Component	Disable	Disable	Disable	Disable	Disable	Disable
Disable/Enable GS1 DataBar Limited 2D Component	Disable	Disable	Disable	Disable	Disable	Disable
Inverse Label Reading	Reads normal only	Reads normal only	Reads normal only	Reads normal only	Reads normal only	Reads normal only

Appendix E

Keyboard Function Key Mappings

Keyboard Model Cross Reference

Table E-1 summarizes the keyboard models, their defined protocol, scancode set, and some unique features. The remaining tables in this chapter provide the function key maps associated with each of the scancode sets.

Table E-1. Keyboard Model Cross Reference

Model Type	I/F ID	Transmission Protocol	Scancode Set	Func. Key Map Support	Use Country Mode
PC/XT Foreign ALT Mode	Wedge A	PC/XT	Scan Set 1	No	No
AT; PS/2 25-286; PS/2 30-286; PS/2 50, 50Z; PS/2 60,70,80,90,95 Foreign ALT Mode	Wedge B	AT/PS2	Scan Set 2	No	No
PS/2 25 and 30 Foreign ALT Mode	Wedge C	AT/PS2	Scan Set 1	No	No
PC/XT U.S. Mode	Wedge D	PC/XT	Scan Set 1	Yes	No
AT; PS/2 25-286; PS/2 30-286; PS/2 50, 50Z; PS/2 60,70,80,90,95 U.S. Mode + specific country support	Wedge E	AT/PS2	Scan Set 2	Yes	Yes
PS/2 25 and 30 U.S. Mode	Wedge F	AT/PS2	Scan Set 1	Yes	No
IBM 3xxx Terminals (122-key keyboard)	Wedge G	AT/PS2	Scan Set 3	Yes	No
IBM 3xxx Terminals (102-key keyboard)	Wedge H	AT/PS2	Scan Set 3	Yes	No
PS55 5530T with JAPANESE DOS (TDOS)	Wedge I	AT/PS2	Japanese DOS	Yes	No
NEC 9801	Wedge J	NEC 9801	NEC 9801	Yes	No

Table E-2. USB Function Key Usage Map

ASCII	Key value	Usage Name	Modifier/ Scancode
02	STX	F11	00h 44h
03	ETX	F12	00h 45h
04	EOT	GUI right Make	80h 00h
05	ENQ	GUI right Break	00h 00h ¹
06	ACK	CTRL right Make	10h 00h
07	BEL	CTRL right Break	00h 00h ¹
08	BS	BS	00h 2Ah
09	HT	TAB right	00h 2Bh
0A	LF	RIGHT arrow (inner keypad)	00h 4Fh
0B	VT	TAB left	02h 2Bh
0C	FF	Enter (right keypad)	00h 58h
0D	CR	CR	00h 28h
0E	SO	INSERT (inner keypad)	00h 49h
0F	SI	PAGE UP (inner keypad)	00h 4Bh
10	DLE	PAGE DOWN (inner keypad)	00h 4Eh
11	DC1	HOME (inner keypad)	00h 4Ah
12	DC2	LEFT arrow (inner keypad)	00h 50h
13	DC3	DOWN arrow (inner keypad)	00h 51h
14	DC4	UP arrow (inner keypad)	00h 52h
15	NAK	F6	00h 3Fh
16	SYN	F1	00h 3Ah
17	ETB	F2	00h 3Bh
18	CAN	F3	00h 3Ch
19	EM	F4	00h 3Dh
1A	SUB	F5	00h 3Eh
1B	ESC	ESC	00h 29h
1C	FS	F7	00h 40h
1D	GS	F8	00h 41h
1E	RS	F9	00h 42h
1F	US	F10	00h 43h

Table E-3. Scanset 1 Function Key Map

ASCII (hex)	ASCII code	Key	Scancode
02	STX	ALT left Make	38h
03	ETX	ALT left Break	B8h
04	EOT	CTRL left Make	1Dh
05	ENQ	CTRL left Break	9Dh
06	ACK	CTRL right Make	E0h 1Dh
07	BEL	CTRL right Break	E0h 9Dh
08	BS	BS	0Eh
09	HT	TAB right	0Fh
0A	LF	RIGHT arrow (inner keypad)	4Dh + E0
0B	VT	TAB left	0Fh + S
0C	FF	Enter (inner keypad)	1Ch + E0
0D	CR	CR	1Ch
0E	SO	INSERT (inner keypad)	52h + E0
0F	SI	PAGE UP (inner keypad)	49h + E0
10	DLE	PAGE DOWN (inner keypad)	51h + E0
11	DC1	HOME (inner keypad)	47h + E0
12	DC2	LEFT arrow (inner keypad)	4Bh + E0
13	DC3	DOWN arrow (inner keypad)	50h + E0
14	DC4	UP arrow (inner keypad)	48h + E0

Table E-4. Scanset 2 Function Key Map

ASCII (hex)	ASCII code	Key	Scancode
02	STX	ALT left Make	11h
03	ETX	ALT left Break	F0h 11h
04	EOT	CTRL left Make	14h
05	ENQ	CTRL left Break	F0h 14h
06	ACK	CTRL right Make	E0h 14h
07	BEL	CTRL right Break	E0h F0h 14h
08	BS	BS	66h
09	HT	TAB right	0Dh
0A	LF	RIGHT arrow (inner keypad)	74h + E0
0B	VT	TAB left	0Dh + S
0C	FF	Enter (right keypad)	5Ah + E0
0D	CR	CR	5Ah
0E	SO	INSERT (inner keypad)	70h + E0
0F	SI	PAGE UP (inner keypad)	7Dh + E0
10	DLE	PAGE DOWN (inner keypad)	7Ah + E0
11	DC1	HOME (inner keypad)	6Ch + E0
12	DC2	LEFT arrow (inner keypad)	6Bh + E0
13	DC3	DOWN arrow (inner keypad)	72h + E0
14	DC4	UP arrow (inner keypad)	75h + E0
15	NAK	F6	0Bh
16	SYN	F1	05h
17	ETB	F2	06h
18	CAN	F3	04h
19	EM	F4	0Ch
1A	SUB	F5	03h
1B	ESC	ESC	76h
1C	FS	F7	83h

1D	GS	F8	0Ah
1E	RS	F9	01h
1F	US	F10	09h

Table E-5. Scanset 3, 102-Key Function Key Map

ASCII (hex)	ASCII code	Key	Scancode
02	STX	ALT left Make	19h
03	ETX	ALT left Break	F0h 19h
04	EOT	CTRL left Make	11h
05	ENQ	CTRL left Break	F0h 11h
06	ACK	CTRL right Make	58h
07	BEL	CTRL right Break	F0h 58h
08	BS	BS	66h
09	HT	TAB right	0Dh
0A	LF	RIGHT arrow (inner keypad)	6Ah
0B	VT	TAB left	0Dh + S
0C	FF	Enter (inner keypad)	79h
0D	CR	CR	5Ah
0E	SO	INSERT (inner keypad)	67h
0F	SI	PAGE UP (inner keypad)	6Fh
10	DLE	PAGE DOWN (inner keypad)	6Dh
11	DC1	HOME (inner keypad)	6Eh
12	DC2	LEFT arrow (inner keypad)	61h
13	DC3	DOWN arrow (inner keypad)	60h
14	DC4	UP arrow (inner keypad)	63h
15	NAK	F6	2Fh
16	SYN	F1	07h
17	ETB	F2	0Fh
18	CAN	F3	17h
19	EM	F4	1Fh
1A	SUB	F5	27h
1B	ESC	ESC	08h
1C	FS	F7	37h
1D	GS	F8	3Fh
1E	RS	F9	47h
1F	US	F10	4Fh

Table E-6. Scanset 3 122-Key Function Key Map

ASCII (hex)	ASCII code	Key	Scancode
02	STX	ALT left Make	19h
03	ETX	ALT left Break	F0h 19h
04	EOT	CTRL left (RESET) Make only	11h
05	ENQ	CTRL left (RESET) Make/Break	11h F0h 11h
06	ACK	ONLINE Enter Make only	58h
07	BEL	ONLINE Enter Make/Break	58h F0h 58h
08	BS	BS	66h
09	HT	TAB right	0Dh
0A	LF	RIGHT arrow (inner keypad)	6Ah
0B	VT	TAB left	0Dh + S
0C	FF	CR (FIELD EXIT) Make only	5Ah F0h 5Ah
0D	CR	CR (FIELD EXIT) Make/Break	5Ah
0E	SO	INSERT (inner keypad)	65h
0F	SI	FIELD +	79h
10	DLE	FIELD -	7Ch
11	DC1	HOME (inner keypad)	62h
12	DC2	LEFT arrow (inner keypad)	61h
13	DC3	DOWN arrow (inner keypad)	60h
14	DC4	UP arrow (inner keypad)	63h
15	NAK	F6	2Fh
16	SYN	F1	07h
17	ETB	F2	0Fh
18	CAN	F3	17h
19	EM	F4	1Fh
1A	SUB	F5	27h
1B	ESC	ESC	08h
1C	FS	F7	37h
1D	GS	F8	3Fh
1E	RS	F9	47h
1F	US	F10	4Fh

Table E-7. Japanese DOS Function Key Map

ASCII value	ASCII code	Key	Scancode
02h	STX	ALT left Make	31h
03h	ETX	ALT left Break	B1h
04h	EOT	CTRL left Make	41h
05h	ENQ	CTRL left Break	C1h
06h	ACK	CTRL right Make	41h
07h	BEL	CTRL right Break	C1h
08h	BS	BS	3Eh
09h	HT	TAB right	3Ch
0Ah	LF	RIGHT arrow (inner keypad)	4Dh
0Bh	VT	TAB left	3Ch + S
0Ch	FF	Enter (right keypad)	60h
0Dh	CR	CR	3Bh
0Eh	SO	INSERT (inner keypad)	52h
0Fh	SI	PAGE UP (inner keypad)	49h
10h	DLE	PAGE DOWN (inner keypad)	51h
11h	DC1	HOME (inner keypad)	4Ch
12h	DC2	LEFT arrow (inner keypad)	4Bh
13h	DC3	DOWN arrow (inner keypad)	4Ah
14h	DC4	UP arrow (inner keypad)	4Eh
15h	NAK	F6	6Dh
16h	SYN	F1	68h
17h	ETB	F2	69h
18h	CAN	F3	6Ah
19h	EM	F4	6Bh
1Ah	SUB	F5	6Ch
1Bh	ESC	ESC	3Dh
1Ch	FS	F7	6Eh
1Dh	GS	F8	6Fh
1Eh	RS	F9	70h
1Fh	US	F10	71h

Table E-8. NEC 9801-Key Function Key Map

ASCII value	ASCII code	Key	Scancode
00h	NUL	unused	n/a
01h	SOH	CR	1Ch
02h	STX	CAPS LOCK ON (make)	71h
03h	ETX	CAPS LOCK OFF (break)	F1h
04h	EOT	CTRL left Make	74h
05h	ENQ	CTRL left Break	F4h
06h	ACK	CTRL-C	60h
07h	BEL	n/a	n/a
08h	BS	BS	0Eh
09h	HT	TAB right	0Fh
0Ah	LF	RIGHT arrow (inner keypad)	3Ch
0Bh	VT	TAB left	0Fh + S
0Ch	FF	DELETE	39h
0Dh	CR	CR	1Ch
0Eh	SO	INSERT (inner keypad)	38h
0Fh	SI	KATAKANA LOCK ON (Make)	72h
10h	DLE	KATAKANA LOCK OFF (Break)	F2h
11h	DC1	HOME (inner keypad)	3Eh
12h	DC2	LEFT arrow (inner keypad)	3Bh
13h	DC3	DOWN arrow (inner keypad)	3Dh
14h	DC4	UP arrow (inner keypad)	3Ah
15h	NAK	F6	67h
16h	SYN	F1	62h
17h	ETB	F2	63h
18h	CAN	F3	64h
19h	EM	F4	65h
1Ah	SUB	F5	66h
1Bh	ESC	ESC	00h
1Ch	FS	F7	68h
1Dh	GS	F8	69h
1Eh	RS	F9	6Ah
1Fh	US	F10	6Bh

NOTES

Appendix F

Host Commands

Accepting RS-232 Commands

The scanner responds to the following RS-232 commands:

COMMAND	ASCII	HEX	COMMENT
Enable Scanner	E	0x45	
Disable Scanner	D	0x44	
Reset Scanner	R	0x52	
Not On File Indication	F	0x46	Long series of beeps
Beep Good Read Tone	B	0x42	Beeps if Good Read Beep is enabled
Force Good Read Tone	!	0x01	Beeps regardless of beep setting
Identification request	i	0x69	Returns long response ¹
Health request	h	0x68	Returns long response ¹
Status request	s	0x73	Returns long response ¹

1. Call Tech Support for information.

If one of the above commands is received, the scanner will perform the steps indicated for the command. Host commands for other interfaces are also available. Contact Tech Support for more details.

Also see the section "[Image Capture to the Host by Host Command](#)" on page 32 for details concerning that feature.

NOTES

Appendix G

Sample Symbols

1D Symbol Samples

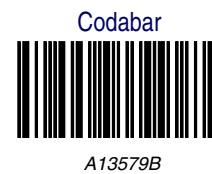
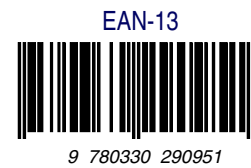
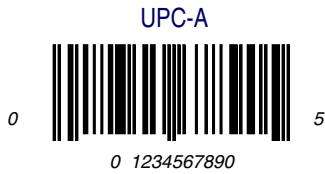

1D Symbol Samples — continued

Code 2 of 5

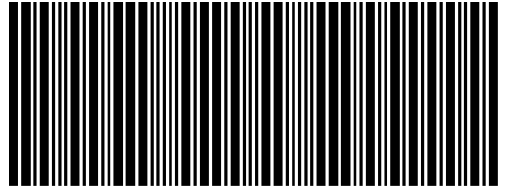

123456

GS1 DataBar Omnidirectional



(01)00123456789012

GS1 DataBar Expanded



0100123456789050

GS1 DataBar Limited

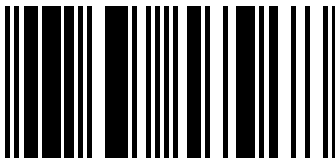

(01)16543210987654

2D Sample Symbols

PDF 417

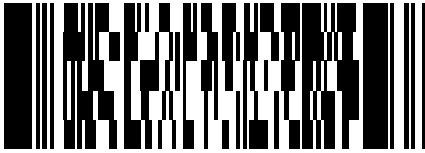

A12B3C

Micro PDF 417



BV17453

Datamatrix

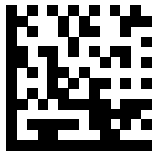

1314H17LL

QR Code

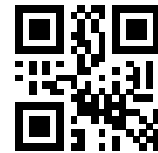

35900G9

Maxicode

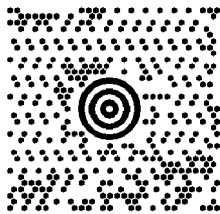

MaxicodeMode4

Aztec



This is an Aztec Code

Composite Sample Symbols

GS1 DataBar Limited Composite

(17) 050923 (10) ABC123



(01) 0 4012345 67890 1

GS1 DataBar Truncated Composite

(17)050923(10)ABC123



(01) 09876543217899

Appendix H

microSD Card

microSDHC Compatibility

At the time of this writing, the microSD card interface for this product supports SD-Memory Card Specifications/ Part 1. Physical Layer Specification; Version 1.01, but the processor MCI can communicate with SDHC Cards. For example, the scanner can perform the functions specified in this appendix for the SDA 2.0 specification. Both FAT16 and FAT32 formats are supported.

Filenames are limited to the 8.3 file naming format (i.e., FILENAME.EXT), and MUST be capitalized.

microSD Card Insertion

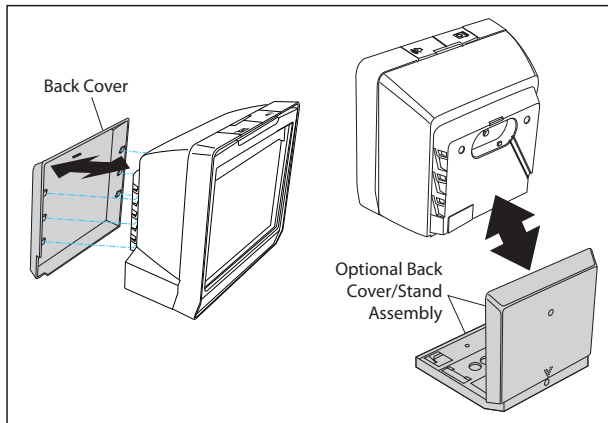

1. Read all of these instructions before starting.
2. If you have not already done so, remove the scanner from its installed position to allow access to the microSD card slot.
3. Separate the scanner from its back cover.
4. Ensure there are no other cables attached to the scanner, then apply power and wait for the reset beep.
5. Lift and rotate the rubber cover to access the card slot, then carefully insert the microSD card into the slot until it "clicks" into place.



The microSD card slot is spring loaded. Keep your finger lightly in place atop the card until you are sure it is fully seated in place. See the illustration on the following page.

CAUTION Use your finger or thumbnail to push in on the top edge of the card to be slightly below flush with the scanner enclosure when inserting or removing the card. This will engage/disengage the spring mechanism.

Never insert tools or other foreign objects into the microSD card slot.

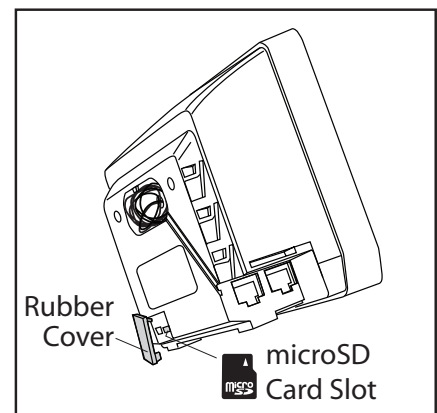

6. If installed properly, you should immediately hear an audible signal upon insertion or removal of a microSD card. Various operations will also be indicated by the scanner's good read LED.

microSD Card Removal

1. Push in gently using your finger or thumbnail to disengage and remove the microSD card. Remember to keep your finger in place atop the card's edge to avoid accidentally "launching" the card from the spring-loaded slot.
2. Reconnect all cables which were disconnected earlier.

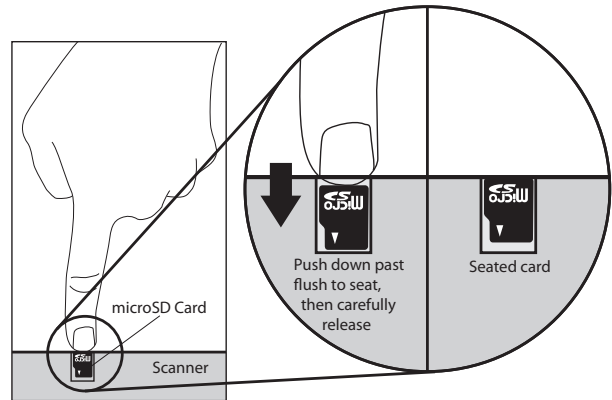

Autorun File Processing

After insertion of the card, the scanner will mount the microSD card and search for the file "AUTORUN.DLS". Embedded in that file is a validation pattern of the ASCII strings "\$START\$" and "\$END\$" located at the respective starting and ending of the file.

If the validation pattern is found, the file may contain any of the following commands. The scanner will parse the file taking action according to these commands. Filenames in *italics* specify a user-defined name.

Example AUTORUN.DLS file:

```
$START$ (required)
CONFIG, FILENAME.TEX
DUMPSTATS, FILENAME.TXT
DUMPCFG, FILENAME.TEX
LOADSW, FILENAME.BIN
$END$ (required)
```

microSD Function Summary

The following table summarizes various functions of microSD card.

	FUNCTION	Image Capture	Export Status	Export Configuration	Load Applic	Load Config	Load CPLD Code	Feature Upgrade*
Direction	Scanner ⇒ microSD Card	√	√	√				
	microSD Card ⇒ Scanner				√	√	√	√
Initiated by	Scanning a label	√	√					
	AUTORUN.DLS file in microSD card		√	√	√	√	√	√

* Contact tech support for any available feature upgrade license.

microSD Function Details

From Scanner to microSD Card

Capture and save an image to a microSD card by scanning a label.

1. Insert the microSD card into the scanner

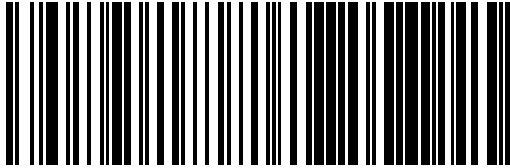

2. Scan the Capture Label

The scanner enters image capture mode.

3. Place the item to be captured in front of the scanner.

Press and release the Camera Button. The scanner will automatically capture and save the image to the microSD card.

4. Upon scanner audio indication of completion, an image is saved to the microSD card.



NOTE

The image file name range is from IMAGE000 to IMAGE999. If the same name already exists in the microSD card, the scanner skips that name and uses the next. For example, if IMAGE000.JPG is already used in the microSD card, the scanner uses IMAGE001.JPG. The time stamp is not real, since the scanner does not have a real time clock.

Image format (.BMP, .JPG), image size (VGA, WVGA, Full size), Brightness (0~9), contrast (0~9), and JPG compression ratio (0~100) are defined in configuration.

Export a Configuration file from the Scanner to the microSD card

By AUTORUN.DLS file

1. Generate a text file by any text editor as follows and save it as AUTORUN.DLS.

```
$START$
```

```
DUMPCFG,SDCONFIG.TEX (Filename can be anything, for example "SOMETHING.TEX")
```

```
$END$
```

2. Save or copy file AUTORUN.DLS to microSD card
3. Insert the microSD card to scanner
4. Wait for 3 seconds,

A scanner configuration file named SDCONFIG.TXT is saved to the microSD card.

Export Scanner Status to microSD card

The data includes scanner ID, statistics and scanner health.

By scanning a label

1. Insert the microSD card into the scanner
2. Scan the status export label

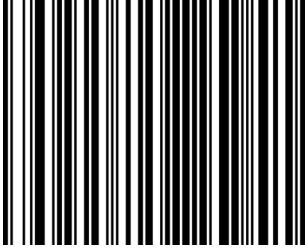

<FNC3>STATUS<CR>

3. Upon scanner audio indication of completion, the scanner status text file named STATUS.TXT is saved to the microSD card.

By AUTORUN.DLS file

1. Generate a text file by any text editor as follows and save it as AUTORUN.DLS

```
$START$  
DUMPSTATS,DMPSTATS.TXT  
$END$
```

2. Save or copy the AUTORUN.DLS file to the microSD card
3. Insert the microSD card into the scanner
4. Wait for about 3 seconds.

A scanner statistics file named DMPSTATS.TXT is saved to the microSD card.

From microSD Card to Scanner

Application code load to scanner

By AUTORUN.DLS file

1. Generate a text file by any text editor as follows and save it as AUTORUN.DLS

```
$START$  
LOADSW,R96-APP1.BIN  
$END$
```

2. Step 2: Save or copy file AUTORUN.DLS to microSD card and copy the application code (example R96-APP1.BIN) to the microSD card.
3. Insert the microSD card into the scanner.
4. Upon scanner audio indication of completion, the application code R96-APP1.BIN is loaded to the scanner. Typically, this takes about 45 seconds.

Configuration load to scanner

By Autorun file

1. Generate a text file by any text editor as follows and save it as AUTORUN.DLS
\$START\$
CONFIG,R96-CFG1.TEX
\$END\$
2. Save or copy the autorun.dls file, and copy the CPLD code (example R96-CFG1.TEX) to the microSD card
3. Insert the microSD card into to the scanner
4. Upon scanner audio indication of completion, configuration R96-CFG1.TEX is loaded to the scanner.

NOTES

Appendix I

Handheld Data Format Requirements

This appendix provides application notes to describe the general format of data that can be accepted by the scanner through the auxiliary port as transmitted from a handheld scanner.

Handheld Data Format Requirements General

- 9600 bps, 8 data bits, 1 stop bit, no parity.
- RTS is used to "bracket" the data received from the handheld: RTS must be asserted high during data transmission, and de-asserted after label transmission is complete. CTS is used to hold off transmission of label from handheld.
- Symbologies requiring fixed lengths (UPC/EAN) will enforce length requirements for validation of the label.
- Handheld will be required to transmit start and stop characters for Codabar and Code 39 labels.
- Appropriate industrial length requirements will be enforced (if configured) for validation of the label.
- Maximum label lengths will be enforced for label validation (i.e. labels longer than the maximum label size will not be validated).
- Standard Datalogic formats generally use a single prefix character. The specific formats are provided below.
- Suggest that handheld turn off audible and visual good read indications to minimize operator confusion.
- Scanner will indicate if a label of improper format has been received from the handheld by sounding a "trill."

Datalogic Handheld Data Format Requirements

The following sections describe label transmission formats that are typically observed in factory configurations of Datalogic handheld scanners.

RSS-14

- Prefix must be ASCII characters 'R4'
- Check character must be included in label
- Application identifier "01" must follow the prefix and precede the base label
- Label length excluding prefix characters must be 16 characters.
- Example: 'R40101044123456789'

RSS Expanded

- Prefix must be ASCII characters 'R4'
- Check character must be included in label

UPC-A

- Number system must be included in label data.
- Check digit must be included in label data and is assumed to be correct.
- Prefix must be an ASCII character 'A' - total length including prefix must be 13.
- Example: 'A060992011187'.

UPC-A with 2-Digit Supplemental

- Number system must be included in label data.
- Check digit must be included in label data and is assumed to be correct.
- Supplemental data is appended to base label.
- Prefix must be an ASCII character 'A' - total length including prefix must be 15.
- Example: 'A06099201118712'.

UPC-A with 5-Digit Supplemental

- Number system must be included in label data
- Check digit must be included in label data and is assumed to be correct
- Prefix must be an ASCII character 'A' - total length including prefix must be 18
- Example: 'A06099201118712345'

UPC-A with Code 128 Supplemental

- Number system must be included in label data.
- Check digit must be included in label data and is assumed to be correct.
- Supplemental data is appended to base label.

-
- Prefix must be an ASCII character 'A' - total length including prefix must be greater or equal to 19 Code 128 Supplemental codes are variable length having a minimum of 2 data characters).
 - Characters immediately following base label must be of the form '8100', '8101' or '8102'.
 - Example: 'A0609920111878100000951'.

UPC-E

- Number system must be included in label data
- Check digit must be included in label data and is assumed to be correct
- Prefix must be an ASCII character 'E' - total length including prefix must be 9
- Example: 'E09988750'

UPC-E with 2-Digit Supplemental

- Number system must be included in label data.
- Check digit must be included in label data and is assumed to be correct.
- Supplemental data is appended to base label.
- Prefix must be an ASCII character 'E' - total length including prefix must be 11.
- Example: 'E0998875012'.

UPC-E with 5-Digit Supplemental

- Number system must be included in label data.
- Check digit must be included in label data and is assumed to be correct.
- Prefix must be an ASCII character 'E' - total length including prefix must be 14.
- Example: 'E0998875012345'.

UPC-E with Code 128 Supplemental

- Number system must be included in label data.
- Check digit must be included in label data and is assumed to be correct.
- Supplemental data is appended to base label.
- Prefix must be an ASCII character 'E' - total length including prefix must be greater or equal to 15 (code 128 Supplemental codes are variable length having a minimum of 2 data characters).
- Characters immediately following base label must be of the form '8100', '8101' or '8102'.
- Example: 'E099887508101000951'.

EAN-8

- Check digit must be included in label data and is assumed to be correct
- Prefix must be an ASCII characters 'FF' - total length including prefix must be 10
- Example: 'FF00210126'

EAN-8 with 2-Digit Supplemental

- Check digit must be included in label data and is assumed to be correct.
- Supplemental data is appended to base label.
- Prefix must be an ASCII characters 'FF' - total length including prefix must be 12.
- Example: 'FF0021012612'.

EAN-8 with 5-Digit Supplemental

- Check digit must be included in label data and is assumed to be correct.
- Prefix must be an ASCII characters 'FF' - total length including prefix must be 15.
- Example: 'FF0021012612345'.

EAN-8 with Code 128 Supplemental

- Check digit must be included in label data and is assumed to be correct.
- Supplemental data is appended to base label.
- Prefix must be an ASCII characters 'FF' - total length including prefix must be greater than 16 (code 128 Supplemental codes are variable length having a minimum of 2 data characters).
- Characters immediately following base label must be of the form '8100', '8101' or '8102'.
- Example: 'FF002101268102000951'.

EAN-13

- Check digit must be included in label data and is assumed to be correct
- Prefix must be an ASCII character 'F'- total length including prefix must be 14
- Example: 'F1101234567891'

EAN-13 with 2-Digit Supplemental

- Check digit must be included in label data and is assumed to be correct
- Supplemental data is appended to base label
- Prefix must be an ASCII character 'F'- total length including prefix must be 16
- Example: 'F110123456789112'

EAN-13 with 5-Digit Supplemental

- Check digit must be included in label data and is assumed to be correct.
- Prefix must be an ASCII character 'F'- total length including prefix must be 19.

-
- Example: 'F110123456789112345'.

EAN-13 with Code 128 Supplemental

- Check digit must be included in label data and is assumed to be correct
- Supplemental data is appended to base label
- Prefix must be an ASCII character 'F'- total length including prefix must be greater or equal to 20 (code 128 Supplemental codes are variable length having a minimum of 2 data characters)
- Characters immediately following base label must be of the form '8100', '8101' or '8102'
- Example: 'F11012345678918100000951'

Code 39

- Check character must be included in label data.
- Label length including start, stop and check characters and excluding prefix character must meet requirements imposed by the main scanner's fixed or variable label length control for this symbology type.
- Start and stop characters "*" must be included in label.
- Prefix must be an ASCII character '*'.
- Example : '**Code 39.TEST*'.

Code 39-Pharmacode

- Check character must be included in label data.
- Label length including start, stop and check characters and excluding prefix character must meet requirements imposed by the main scanner's fixed or variable label length control for this symbology type.
- Start and stop characters "*" must be included in label.
- Prefix must be an ASCII character 'p'.
- Example: 'p*123456789*'.

I 2 of 5

- Check character must be included in label data.
- Label length including check characters and excluding prefix character must meet requirements imposed by the main scanner's fixed or variable label length control for this symbology type.
- Prefix must be an ASCII character 'i'.
- Example: 'i0123456789'.

Codabar

- Check character must be included in label data.
- Label length including check character and excluding prefix character must meet requirements imposed by the main scanner's fixed or variable label length control for this symbology type.
- Prefix must be an ASCII character '%'.
• Start stop character sets must meet the matching requirement set forth by the scanner configuration item *Start/Stop Character Match*.
- Start stop character sets must be of the form ABCD/ABCD and must be included in the label.
- Example: '%s\$99.95s' (the lower case 's' at each end of the example is a placeholder for the start stop character set).

Code 128

- Prefix must be an ASCII character '#'.
• Label length excluding prefix character or function code 3 for Code 128 programming labels must meet requirements imposed by the main scanner's fixed or variable label length control for this symbology type.
- Function characters may be transmitted as a hexadecimal value 8x. Where x correlates to function characters 1 thru 4 as follows:
 - x80 = function code 1
 - x81 = function code 2
 - x82 = function code 3
 - x83 = function code 4
- For Code 128 programming labels the format is of the general form '#/82nnnnn/r ' - /82 is hexadecimal 82 and /r is carriage return.
- Example: '#Code_128.Test'.

MSI

- Check character must be included in label data.
- Label length including check character and excluding prefix character must meet requirements imposed by the main scanner's fixed or variable label length control for this symbology type.
- Prefix must be an ASCII character '@'.
- Example: '@144769254'.

Code 93

- Prefix must be an ASCII character '&'.
- Label length excluding prefix character must meet requirements imposed by the main scanner's fixed or variable label length control for this symbology type.
- Example: '&Code93-test'.

PDF417

- Prefix must be an ASCII character 'P'.
- Label length excluding prefix character cannot exceed 300 characters. In addition to this, label length excluding prefix character must meet requirements imposed by the main scanner's fixed or variable label length control for this symbology type.

AIM Formats

AIM specifies a 3-character string that is attached as a prefix to the label data for transmission. Because AIM specifies one identifier for UPC-A, UPC-E and EAN-13 labels, UPC-A, UPC-E and EAN-13 will be received from the handheld and transmitted by the scanner as EAN-13. The ']' character must be the first character received in the label transmission from the handheld.

The following sections describe the prefix strings and identify what specific label characteristics can be supported.

UPC-A

- AIM does not specify UPC-A as a separate symbology using this transmission format - labels will be transmitted as EAN-13.
- Example: 'JE00060992011187'.

UPC-E

- AIM does not specify UPC-E as a separate symbology using this transmission format - labels will be transmitted as EAN-13.
- Example: 'JE00000000998875'.

EAN-13

- Check digit must be included in label data and is assumed to be correct.
- Prefix must be ASCII characters 'JE0' - total length including prefix must be 16.
- Example: 'JE01101234567891'.

EAN-8

- Check digit must be included in label data and is assumed to be correct.
- Prefix must be ASCII characters 'JE4' - total length including prefix must be 11.
- Example: 'JE400210126'.

2-Digit Supplemental

- Supplemental data is appended to any EAN base label.
- Prefix must be ASCII characters 'JE1'.
- length of Supplemental data including prefix must be 5. Total required length is 21 for EAN-13 and 16 for EAN-8.
- Examples: addon portion is highlighted data is underlined.

UPC-A 2-Digit addon	'JE00060992011187JE1 <u>12</u> '
UPC-E 2-Digit addon	'JE00000000998875JE1 <u>12</u> '
EAN-8 2-Digit addon	'JE400210126JE1 <u>12</u> '
EAN-13 2-Digit addon	'JE01101234567891JE1 <u>12</u> '

5-Digit Supplemental

- Supplemental data is appended to any EAN base label.
- Prefix must be ASCII characters 'JE2'.
- Length of supplemental data including prefix must be 8. Total required length is 24 for EAN-13 and 19 for EAN-8.
- Examples: addon portion is highlighted data is underlined.

UPC-A 5-Digit addon	'JE00060992011187JE2 <u>12345</u> '
UPC-E 5-Digit addon	'JE00000000998875JE2 <u>12345</u> '
EAN-8 5-Digit addon	'JE400210126JE2 <u>12345</u> '
EAN-13 5-Digit addon	'JE01101234567891JE2 <u>12345</u> '

Code 128 Supplemental

- Supplemental data is appended to any EAN base label.
- Prefix must be ASCII characters ']C0'.
- length of Supplemental data including prefix is variable but must be at least 9.
- Examples: addon portion is highlighted data is underlined.

UPC-A Code 128 addon	'E00060992011187] C08 <u>100000951</u> '
UPC-E Code 128 addon	'E00000000998875] C08 <u>100000951</u> '
EAN-8 Code 128 addon	'E400210126] C08 <u>100000951</u> '
EAN-13 Code 128 addon	'E01101234567891] C08 <u>100000951</u> '

Bookland

- The 'Bookland' / ISBN code will be formatted as a vendor specific AIM label.
- Prefix must be ASCII characters ']X0'.
- length of label data including prefix is 13.
- Examples: ']X01234567890'.

Code 39

- Check character must be included in label data.
- Label length including start, stop and check characters and excluding prefix characters must meet requirements imposed by the main scanner's fixed or variable label length control for this symbology type.
- Start and stop characters "*" must be included in label.
- Prefix must be ASCII characters ']A0' or ']A1'.
- Example: '*]A0Code 39.TEST*'

Codabar

- Check character must be included in label data.
- Label length including check character and excluding prefix characters must meet requirements imposed by the main scanner's fixed or variable label length control for this symbology type.
- Prefix must be ASCII characters ']F0'.
- Start stop character sets must meet the matching requirement set forth by the scanner configuration item *Start/Stop Character Match*.
- Start stop character sets s must be of the form ABCD/ABCD and must be included in the label.
- Example: ']F0s\$99.95s' (the lower case 's' at each end of the example is a placeholder for the start stop character set).

MSI

- Check character must be included in label data.
- Label length including check character and excluding prefix characters must meet requirements imposed by the main scanner's fixed or variable label length control for this symbology type.
- Prefix must be ASCII characters ']M0'.
- Example: ']M0144769254'.

Code 93

- Prefix must be ASCII characters ']G0'.
- Label length excluding prefix characters must meet requirements imposed by the main scanner's fixed or variable label length control for this symbology type.
- Example : ']G0Code93-test'.

RSS-14

- Prefix must be ASCII characters 'je0'.
- Check character must be included in label.
- Label length excluding prefix characters must be 14 characters.
- Example: 'je001044123456789'.

RSS Expanded

- Prefix must be ASCII characters 'je0'.
- Label length excluding prefix characters must be at least 1 character. Maximum length is the maximum label size supported by the scanner.
- Example: 'je001900123456789083103001750'.

I 2 of 5

- Check character must be included in label data.
- Label length including check characters and excluding prefix characters must meet requirements imposed by the main scanner's fixed or variable label length control for this symbology type.
- Prefix must be an ASCII character 'I1' (other prefixes specify different check character properties which are not supported).
- Example: 'I10123456789'.

Code 128 / EAN128

- Prefix must be either ASCII characters ']C0', ']C1' or ']C2'.
- Label length excluding prefix character must meet requirements imposed by the main scanner's fixed or variable label length control for this symbology type.
- If EAN-128 Symbology is Enabled and prefix is ']C1', label will be identified as an EAN128 otherwise it is identified as a Code 128.
- A prefix of ']C0' designates that no function code is present in the 1st or 2nd character position.
- A prefix of ']C2' designates that a function code 1 is present in the 2nd character.
- Example : ']C0Code_128.Test'.

PDF417

- Prefix must be an ASCII characters ']L0'.
- Label length excluding prefix character cannot exceed 300 characters. In addition to this, label length excluding prefix character must meet requirements imposed by the main scanner's fixed or variable label length control for this symbology type.
- Example : ']L0pdf_test_label'.

"Unknown" AIM ID (an AIM ID which is not specified above)

If a label is received that does not have an AIM ID as specified above, and the first three label characters qualify as follows...

- The first character is a '['
- The second character is a capital or small letter
- The third character is a digit

...then the label type is set to GENERIC_DATA and the "unknown" AIM ID is left-appended to the beginning of the label data.

NOTES

NOTES

ASCII Chart

ASCII Char.	Hex No.	ASCII Char.	Hex No.	ASCII Char.	Hex No.	ASCII Char.	Hex No.
NUL	00	SP	20	@	40	'	60
SOH	01	!	21	A	41	a	61
STX	02	"	22	B	42	b	62
ETX	03	#	23	C	43	c	63
EOT	04	\$	24	D	44	d	64
ENQ	05	%	25	E	45	e	65
ACK	06	&	26	F	46	f	66
BEL	07	'	27	G	47	g	67
BS	08	(28	H	48	h	68
HT	09)	29	I	49	i	69
LF	0A	*	2A	J	4A	j	6A
VT	0B	+	2B	K	4B	k	6B
FF	0C	,	2C	L	4C	l	6C
CR	0D	-	2D	M	4D	m	6D
SO	0E	.	2E	N	4E	n	6E
SI	0F	/	2F	O	4F	o	6F
DLE	10	0	30	P	50	p	70
DC1	11	1	31	Q	51	q	71
DC2	12	2	32	R	52	r	72
DC3	13	3	33	S	53	s	73
DC4	14	4	34	T	54	t	74
NAK	15	5	35	U	55	u	75
SYN	16	6	36	V	56	v	76
ETB	17	7	37	W	57	w	77
CAN	18	8	38	X	58	x	78
EM	19	9	39	Y	59	y	79
SUB	1A	:	3A	Z	5A	z	7A
ESC	1B	;	3B	[5B	{	7B
FS	1C	<	3C	\	5C		7C
GS	1D	=	3D]	5D	}	7D
RS	1E	>	3E	^	5E	~	7E
US	1F	?	3F	_	5F	DEL	7F

Australia

Datalogic Scanning Pty Ltd
Telephone: [61] (2) 9870 3200
australia.scanning@datalogic.com

France and Benelux

Datalogic Scanning SAS
Telephone: [33].01.64.86.71.00
france.scanning@datalogic.com

Germany

Datalogic Scanning GmbH
Telephone: 49 (0) 61 51/93 58-0
germany.scanning@datalogic.com

India

Datalogic Scanning India
Telephone: 91- 22 - 64504739
india.scanning@datalogic.com

Italy

Datalogic Scanning SpA
Telephone: [39] (0) 39/62903.1
italy.scanning@datalogic.com

Japan

Datalogic Scanning KK
Telephone: 81 (0)3 3491 6761
japan.scanning@datalogic.com

Latin America

Datalogic Scanning, Inc
Telephone: (305) 742-2206
latinamerica.scanning@datalogic.com

Singapore

Datalogic Scanning Singapore PTE LTD
Telephone: (65) 6435-1311
singapore.scanning@datalogic.com

Iberia

Datalogic Scanning SAS Sucursal en España
Telephone: 34 91 746 28 60
spain.scanning@datalogic.com

United Kingdom

Datalogic Scanning LTD
Telephone: 44 (0) 1582 464900
uk.scanning@datalogic.com



www.scanning.datalogic.com

Datalogic Scanning, Inc.

959 Terry Street
Eugene, OR 97402
USA
Telephone: (541) 683-5700
Fax: (541) 345-7140

